

CONTINUED FROM PART 1

INTRODUCTION

In view of the recent amendment made in the Designs (Amendment) Rules, 2008 with effect from 17/06/2008, Publication of the matter relating to Designs is being published in the Official Journal of The Patent Office. This Journal is being published on weekly basis on every Friday covering the various proceedings on Designs as required according to the provisions of under Rule 22, 25, 27 and 39 of the Design (Amendment) Rules, 2008. All the enquiries on this Official Journal and other information as required by the public should be addressed to the Controller General of Patents, Designs & Trade Marks. Suggestions and comments are requested from all quarters so that the content can be enriched.

THE DESIGNS ACT 2000
SECTION 30
DESIGN ASSIGNMENT

(1)

The Design stands in the name of **RECKITT & COLMAN PRODUCTS LIMITED**, registered under the Designs Act, 1911 has been assigned in the Register of Design in the name as follows:-

Design No.	Class	Name
177988	4	RECKITT BENCKISER (UK) LIMITED, A COMPANY REGISTERED IN ENGLAND AND WALES UNDER NO. 3982446, OF 103-105 BATH ROAD, SLOUGH, BERKSHIRE, SL1 3UH, UNITED KINGDOM.

(2)

The Design stands in the name of **RECKITT & COLMAN PRODUCTS LIMITED**, registered under the Designs Act, 1911 has been assigned in the Register of Design in the name as follows:-

Design No.	Class	Name
178183	4	RECKITT BENCKISER (UK) LIMITED, A COMPANY REGISTERED IN ENGLAND AND WALES UNDER NO. 3982446, OF 103-105 BATH ROAD, SLOUGH, BERKSHIRE, SL1 3UH, UNITED KINGDOM.

DESIGN ACT 2000
(Under Section 31)
RECTIFICATION OF REGISTER

(1)

M/s. K & S Partners, the agent of the Regd. Proprietor Cipla Limited, an Indian Company of 289 Bellasis Road, Mumbai Central, Mumbai-400008, Maharashtra, India has filed an application on Form-17 for rectification of the name of the article from the Register of Design as follows:-

Design Nos	Entered name of the article	Changed to
213792	End Cap for Aerosol Delivery Device	Valve body for aerosol delivery device

Notice of opposition to the rectification of Register of Design may be given as per rule 40 of the Design Rule, 2001.

(2)

M/s. K & S Partners, the agent of the Regd. Proprietor Cipla Limited, an Indian Company of 289 Bellasis Road, Mumbai Central, Mumbai-400008, Maharashtra, India has filed an application on Form-17 for rectification of the name of the article from the Register of Design as follows:-

Design Nos	Entered name of the article	Changed to
213791	Canister for Aerosol Delivery Device	Valve chamber for aerosol delivery device

Notice of opposition to the rectification of Register of Design may be given as per rule 40 of the Design Rule, 2001.

(3)

M/s. K & S Partners, the agent of the Regd. Proprietor Cipla Limited, an Indian Company of 289 Bellasis Road, Mumbai Central, Mumbai-400008, Maharashtra, India has filed an application on Form-17 for rectification of the name of the article from the Register of Design as follows:-

Design Nos	Entered name of the article	Changed to
213790	Aerosol Delivery Device	Stem for aerosol delivery device

Notice of opposition to the rectification of Register of Design may be given as per rule 40 of the Design Rule, 2001.

(4)

M/s. K & S Partners, the agent of the Regd. Proprietor Cipla Limited, an Indian Company of 289 Bellasis Road, Mumbai Central, Mumbai-400008, Maharashtra, India has filed an application on Form-17 for rectification of the name of the article from the Register of Design as follows:-

Design Nos	Entered name of the article	Changed to
213789	Sealing piece for Aerosol Delivery Device	Seat gasket for aerosol delivery device

Notice of opposition to the rectification of Register of Design may be given as per rule 40 of the Design Rule, 2001.

(5)

M/s. K & S Partners, the agent of the Regd. Proprietor Cipla Limited, an Indian Company of 289 Bellasis Road, Mumbai Central, Mumbai-400008, Maharashtra, India has filed an application on Form-17 for rectification of the name of the article from the Register of Design as follows:-

Design Nos	Entered name of the article	Changed to
213788	Seat gasket for Aerosol Delivery Device	End cap for aerosol delivery device

Notice of opposition to the rectification of Register of Design may be given as per rule 40 of the Design Rule, 2001.

(6)

M/s. K & S Partners, the agent of the Regd. Proprietor Cipla Limited, an Indian Company of 289 Bellasis Road, Mumbai Central, Mumbai-400008, Maharashtra, India has filed an application on Form-17 for rectification of the name of the article from the Register of Design as follows:-

Design Nos	Entered name of the article	Changed to
213787	Stem for Aerosol Delivery Device	Sealing piece for aerosol delivery device

Notice of opposition to the rectification of Register of Design may be given as per rule 40 of the Design Rule, 2001.

(7)

M/s. K & S Partners, the agent of the Regd. Proprietor Cipla Limited, an Indian Company of 289 Bellasis Road, Mumbai Central, Mumbai-400008, Maharashtra, India has filed an application on Form-17 for rectification of the name of the article from the Register of Design as follows:-

Design Nos	Entered name of the article	Changed to
213786	Valve body for Aerosol Delivery Device	Canister for aerosol delivery device

Notice of opposition to the rectification of Register of Design may be given as per rule 40 of the Design Rule, 2001.

(8)

M/s. K & S Partners, the agent of the Regd. Proprietor Cipla Limited, an Indian Company of 289 Bellasis Road, Mumbai Central, Mumbai-400008, Maharashtra, India has filed an application on Form-17 for rectification of the name of the article from the Register of Design as follows:-

Design Nos	Entered name of the article	Changed to
213785	Valve Chamber for Aerosol Delivery Device	Aerosol delivery device

Notice of opposition to the rectification of Register of Design may be given as per rule 40 of the Design Rule, 2001.

CANCELLATION PROCEEDINGS
u/s 19(1) of the Designs Act, 2000 & Designs Rules 2001 as amended
Designs (Amendment) Rules, 2008

(1)

“Mahesh Shyama Shetty, trading as Sairaj Industries, a proprietary concern, having address at Unit No.91, Virwani Industries Estate, Ground Floor, Western Express Highway, Goregaon (E), Mumbai-400063 filed an application on 16/6/2009 for cancellation of registration of registered Design No. 198147 under class 31-00 in the name of Maya Appliances (P) Ltd.”

(2)

“Mahesh Shyama Shetty, trading as Sairaj Industries, a proprietary concern, having address at Unit No.91, Virwani Industries Estate, Ground Floor, Western Express Highway, Goregaon (E), Mumbai-400063 filed an application on 16/6/2009 for cancellation of registration of registered Design No. 205741 dated 22/8/2006 under class 31-00 in the name of M/s. Maya Appliances (P) Ltd.”

(3)

“Shri Nachhatar Singh, Managing Director of Standard Corporation India Ltd. having its office at Standard Chowk, Barnala-148101, Punjab filed an application on 8/9/2009 for cancellation of registration of registered Design No. 216315 under class 15-99 titled as ‘Gear for use in Track Harvester Combine’ in the name of Kartar Agro Industries (Pvt) Ltd..”

(4)

“Shri Nitesh Panchal, sole proprietor of M/s.Vidhi Enterprise having its principla place of business at 33, Shreekunj Society, Nr. Rannapark, Ghatlodia, Ahmedabad-380061, Gujarat India filed an application on 30/6/2009 for cancellation of registration of registered Design No. 200628 under class 09-07 in the name of Patel Brothers.”

(5)

“Shri Nitesh Panchal, sole proprietor of M/s.Vidhi Enterprise having its principla place of business at 33, Shreekunj Society, Nr. Rannapark, Ghatlodia, Ahmedabad-380061, Gujarat India filed an application on 30/6/2009 for cancellation of registration of registered Design No. 212323 under class 08-07 in the name of Patel Brothers.”

(6)

“Shri Nitesh Panchal, sole proprietor of M/s.Vidhi Enterprise having its principla place of business at 33, Shreekunj Society, Nr. Rannapark, Ghatlodia, Ahmedabad-380061, Gujarat India filed an application on 30/6/2009 for cancellation of registration of registered Design No. 212324 under class 08-07 in the name of Patel Brothers.”

(7)

“Shri Nitesh Panchal, sole proprietor of M/s.Vidhi Enterprise having its principal place of business at 33, Shreekunj Society, Nr. Rannapark, Ghatlodia, Ahmedabad-380061, Gujarat India filed an application on 30/6/2009 for cancellation of registration of registered Design No. 212325 under class 08-07 in the name of Patel Brothers.”

(8)

“Shri Nachhatar Singh, Managing Director of Standard Corporation India Ltd. having its office at Standard Chowk, Barnala-148101, Punjab filed an application on 8/9/2009 for cancellation of registration of registered Design No. 212807 under class 15-03 titled as ‘Straw Walker for use in Track Harvester Combine’ in the name of Kartar Agro Industries (Pvt) Ltd..”

(9)



“Shri Nachhatar Singh, Managing Director of Standard Corporation India Ltd. having its office at Standard Chowk, Barnala-148101, Punjab filed an application on 8/9/2009 for cancellation of registration of registered Design No. 212900 under class 15-03 titled as ‘Peg Tooth Threshing Cylinder for use in Track Harvester Combine’ in the name of Kartar Agro Industries (Pvt) Ltd..”

CANCELLATION PROCEEDINGS
under Section 19(1) of the Designs Act, 2000

“The Ld. Asstt. Controller of Patents & Designs passed an order on 16/11/2009 to dismiss the petition filed by Hindustan Lever Limited, 165/166 Backbay Reclamation, Mumbai-20 on 13/5/2004 for cancellation of the registration of registered Design No. 185087 dated 20/3/2001 under class 09-01 titled as ‘Bottle’ in the name of Neeraj Malhotra, an Indian national, trading as Canauthentic, an Indian proprietary concern, GD-29, Pitampura, Delhi-110034, India.’

REGISTRATION OF DESIGNS

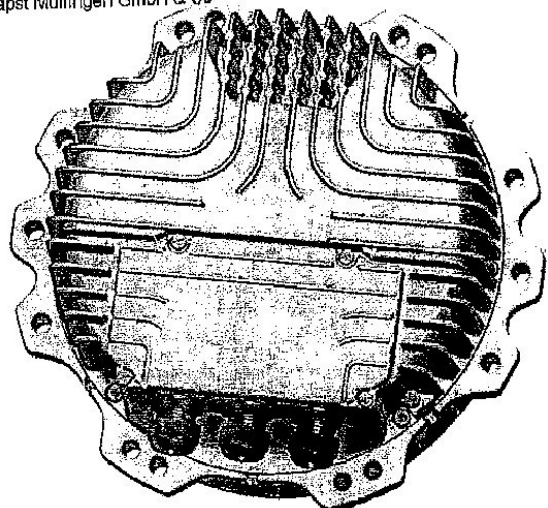

The following designs have been registered. They are now open for public inspection. In the following each entry the Date of Registration is shown. The Priority Number, Priority Date and Priority Country are also shown.

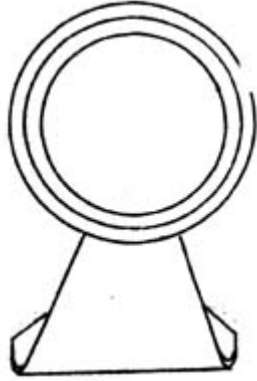
Design Number	208840	
Class	26-03	
1)Schreder S.A. Rue De Lusambo 67, B-1190 Brussels, Belgium		
Date of Registration	09/03/2007	
Title	Lighting Apparatus	
Priority – 06-090.970 11/09/2006 OHIM		
Design Number	211984	
Class	21-01	
1)Three Pagodas Pty Ltd. 16 Courallie Road, Northbridge NSW 2063, Australia		
Date of Registration	21/08/2007	
Title	Toy (Bear Figure)	
Priority – 314090 22/02/2007 Australia		
Design Number	212922	<p>Name of Applicant: ebm-papst Mulfingen GmbH & Co. NO. OF SHEETS Sheet No. 03</p> 
Class	13-01	
1)Ebm-Papst Mulfingen GMBH & Co. Bachmuhle 2, 74673 Mulfingen, Germany.		
Date of Registration	12/04/2007	
Title	Motor Housing	
Priority – 000706478-0001 12/04/2007 OHIM		

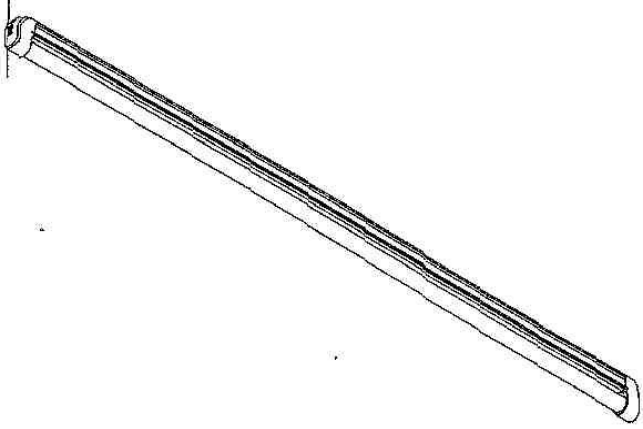

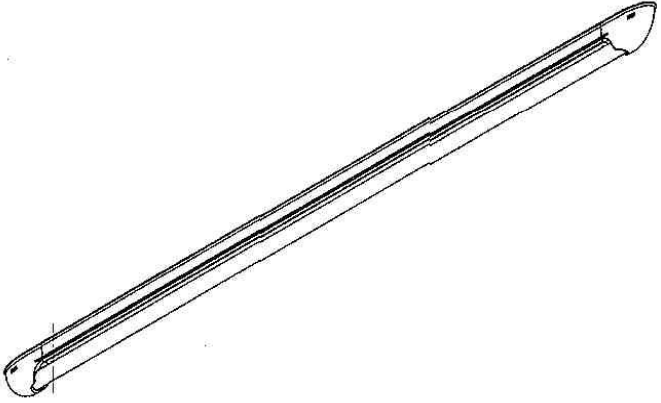
Design Number	213320	
Class	06-07	
1)Shreem Swarnam Design Concepts Pvt.Ltd. Congress Bhawan, Saproon, Dist-Solan (HP) 173 211, India.		
Date of Registration	06/11/2007	
Title	Photo Frame	
Priority – NA		



Design Number	213570	
Class	26-05	
1)KONINKLIJKE PHILIPS ELECTRONICS N.V. GROENEWOUDSEWEG 1, 5621 BA EINDHOVEN, THE NETHERLANDS.		
Date of Registration	31/05/2007	
Title	Luminaire(Batten)	
Priority – 000732623-0001 31/05/2007 OHIM		

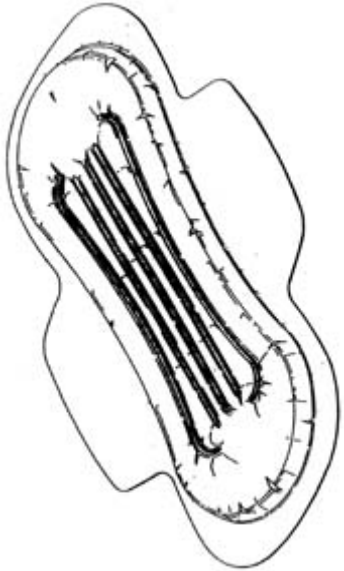
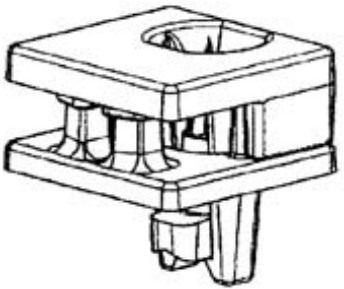

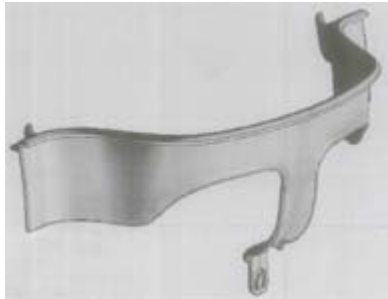
Design Number	213572	
Class	26-05	
1)KONINKLIJKE PHILIPS ELECTRONICS N.V. GROENEWOUDSEWEG 1, 5621 BA EINDHOVEN, THE NETHERLANDS.		
Date of Registration	31/05/2007	
Title	Luminaire(Batten)	
Priority – 000732623-0003 31/05/2007 OHIM		

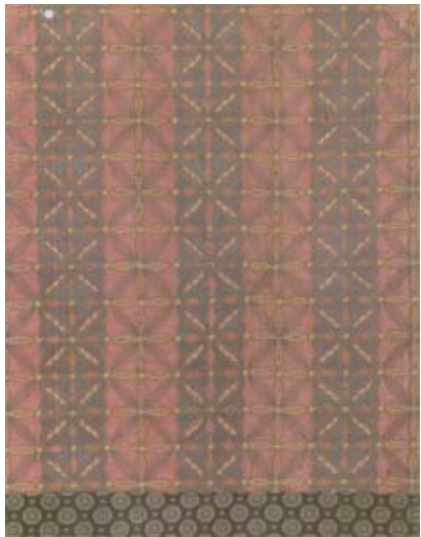

Design Number	214183	
Class	09-01	
1)Ttk Prestige Limited 11th Floor Brigade Towers 135,Brigade Road Bangalore-560025 Karnataka India		
Date of Registration	09/01/2008	
Title	Container	
Priority – NA		
Design Number	214835	
Class	14-03	
1)Koninklijke Philips Electronics N.V. Groenewoudseweg 1, 5621 BA Eindhoven, The Netherlands.		
Date of Registration	21/02/2008	
Title	Parent Unit for Babyphone	
Priority – 000776588-0004 21/08/2007 OHIM		
Design Number	215081	
Class	06-13	
1)Eicher Goodearth Limited Echer House, 12 Commercial Complex, Greater Kailash-Part II (Masjid Moth), New Delhi-110048, India		
Date of Registration	03/03/2008	
Title	Bed Spread	
Priority – NA		

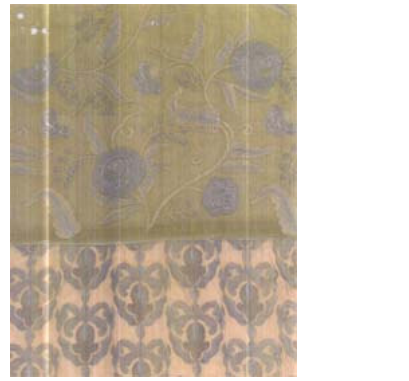
Design Number	215963	
Class	06-02	
1)Mykko Lossingstraat 146, B-2900 Schoten, Belgium		
Date of Registration	22/04/2008	
Title	Travel Cots	
Priority – 000812821 22/10/2007 OHIM		
Design Number	216027	
Class	24-04	
1)McNeil PPC, Inc. 199 Grandview Road, Skillman, NJ 08558, USA		
Date of Registration	25/04/2008	
Title	Sanitary Napkin	
Priority – 29/296,850 30/10/2007 U.S.A.		
Design Number	217039	
Class	08-08	
1)Swatch AG (Swatch SA) (Swatch Ltd). Jakob-Stampfli-Strasse 94, Beil/Bienne, Switzerland		
Date of Registration	08/07/2008	
Title	Fastening Device for Watch Display	
Priority – DM/069 641 08/01/2008 WIPO		

Design Number	217059	
Class	06-06	
1)Peter Opsvik AS Pilestredet 27 H N-0164 Oslo, Norway		
Date of Registration	09/07/2008	
Title	Safety Bow	
Priority – 20080014 11/01/2008 Norway		
Design Number	217381	
Class	05-05	
1)Charming Apparels (P) Ltd. 402-405, 1st Floor, Main Road, Chandni Chowk, Delhi-110006, India		
Date of Registration	28/07/2008	
Title	Textile Fabric	
Priority – NA		
Design Number	217382	
Class	05-05	
1)Charming Apparels (P) Ltd. 402-405, 1st Floor, Main Road, Chandni Chowk, Delhi-110006, India		
Date of Registration	28/07/2008	
Title	Textile Fabric	
Priority – NA		

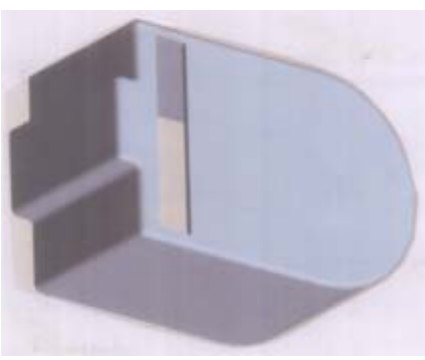
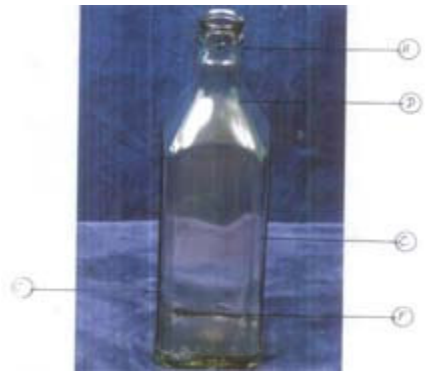

Design Number	217384	
Class	05-05	
1)Charming Apparels (P) Ltd. 402-405, 1st Floor, Main Road, Chandni Chowk, Delhi-110006, India		
Date of Registration	28/07/2008	
Title	Textile Fabric	
Priority – NA		
Design Number	217385	
Class	05-05	
1)Charming Apparels (P) Ltd. 402-405, 1st Floor, Main Road, Chandni Chowk, Delhi-110006, India		
Date of Registration	28/07/2008	
Title	Textile Fabric	
Priority – NA		
Design Number	217386	
Class	05-05	
1)Charming Apparels (P) Ltd. 402-405, 1st Floor, Main Road, Chandni Chowk, Delhi-110006, India		
Date of Registration	28/07/2008	
Title	Textile Febric	
Priority – NA		

Design Number	217387	
Class	05-05	
1)Charming Apparels (P) Ltd. 402-405, 1st Floor, Main Road, Chandni Chowk, Delhi-110006, India		
Date of Registration	28/07/2008	
Title	Textile Fabric	
Priority – NA		
Design Number	217394	
Class	13-03	
1)Su-Kam Power Systems Ltd. Plot No. WZ-1401/2, Nangal Raya, New Delhi-110046, India.		
Date of Registration	28/07/2008	
Title	Front Panel of Inverter	
Priority – NA		
Design Number	217396	
Class	13-03	
1)Su-Kam Power Systems Ltd. Plot No. WZ-1401/2, Nangal Raya, New Delhi-110 046, India		
Date of Registration	28/07/2008	
Title	Front Panel of Inverter	
Priority – NA		

Design Number	217402	
Class	13-02	
1)Su-Kam Power Systems Ltd. Plot No. WZ-1401/2, Nangal Raya, New Delhi-110 046, India		
Date of Registration	28/07/2008	
Title	Battery Terminal Protector	
Priority – NA		
Design Number	217423	
Class	09-01	
1)Khoday India Limited Brewery House, 7th mile, Kanakapura Road, Bangalore-560 062, Karnataka State, India		
Date of Registration	30/07/2008	
Title	Bottle without Cap	
Priority – NA		
Design Number	217425	
Class	06-03	
1)Jacob Thomas Pathupallil (H), Ponkunnam P.O., Kottayam District, Kerela, India 2)Khoday India Limited		
Date of Registration	30/07/2008	
Title	Bottle without Cap	
Priority – NA		

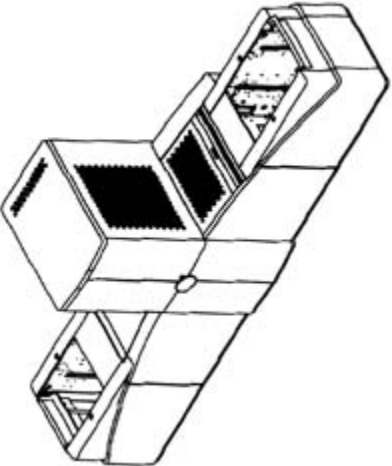
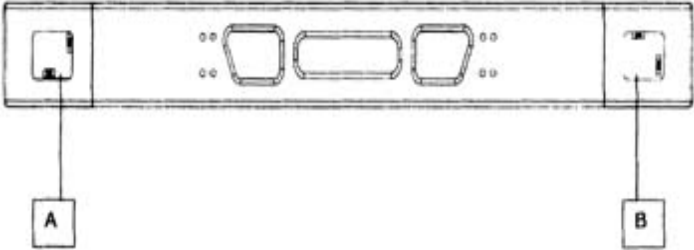
Design Number	217446	
Class	26-06	
1)Toyota Jidosha Kabushiki Kaisha 1, Toyota-cho, Toyota-shi, Aichiken, 471-8571, Japan		
Date of Registration	30/07/2008	
Title	Rear Combination Lamp for an Automobile	
Priority – NA		
Design Number	217449	
Class	12-16	
1)Toyota Jidosha Kabushiki Kaisha 1, Toyota-cho, Toyota-shi, Aichiken, 471-8571, Japan		
Date of Registration	30/07/2008	
Title	Front Grille for an Automobile	
Priority – NA		
Design Number	217458	
Class	14-03	
1)Nokia Corporation Keilalahdentie 4, Fin-02150 Espoo Finland		
Date of Registration	30/07/2008	
Title	Remote Control Unit for Multimedia Devices	
Priority – 29/317,290 25/04/2008 U.S.A.		

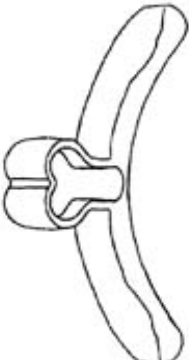

Design Number	217494	
Class	08-01	
1)Robert Bosch GmbH Postfach 30 20 20, 70442, stuttgart, Germany		
Date of Registration	31/07/2008	
Title	Cordless Rotary Hammer	
Priority – 000878954 14/02/2008 OHIM		
Design Number	217559	
Class	18-02	
1)Jadason Scientific (Dongguan) Ltd. Chashan Industries Zone, Chashan Dongguan, Guangdong, 523373, R. P. China 2)Jadason Enterprises (HK) Limited		
Date of Registration	05/08/2008	
Title	Printer	
Priority – 200830046259.5 11/04/2008China		
Design Number	217563	
Class	12-16	
1)Tata Motors Limited Bombay House, 24 Homi Mody Street, Hutatma Chowk, Mumbai 400001, Maharashtra, India		
Date of Registration	05/08/2008	
Title	Bumper with Fog Lamp Assembly for Vehicles	
Priority – NA		

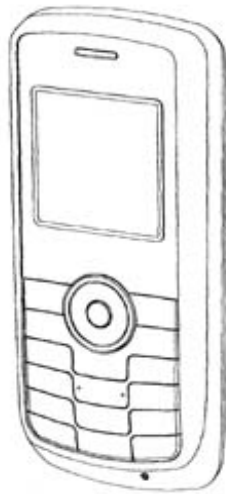
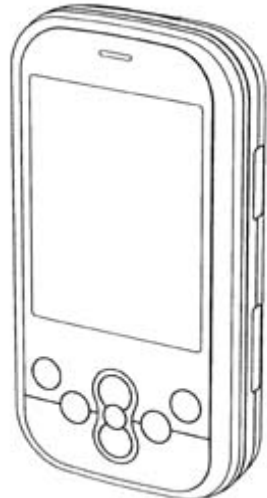
Design Number	217577	
Class	23-02	
1)Kohler Co., 444 Highland Drive, Kohler, Wisconsin 53044, United States of America		
Date of Registration	06/08/2008	
Title	Handshower	
Priority – 29/303,348 07/02/2008 U.S.A.		
Design Number	217646	
Class	01-06	
1)Paragon Products B. V. Industrieweg 12 9641 HM Veendam the Netherlands		
Date of Registration	11/08/2008	
Title	Dog Chews	
Priority – 000876917-0003 12/02/2008 OHIM		
Design Number	217716	
Class	14-03	
1)LG Electronics Inc. 20, Yeouido-Dong, Yeongdeungpo-Gu, Seoul, 150-721, Korea		
Date of Registration	12/08/2008	
Title	Mobile Phone	
Priority – 30-2008-0008546 28/02/2008 Korea(South)		

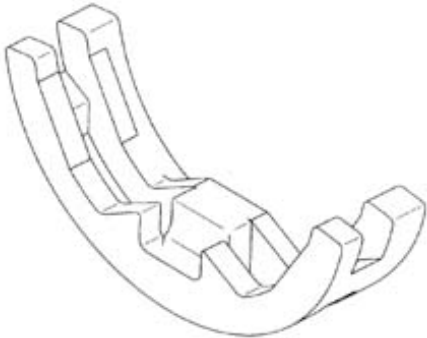
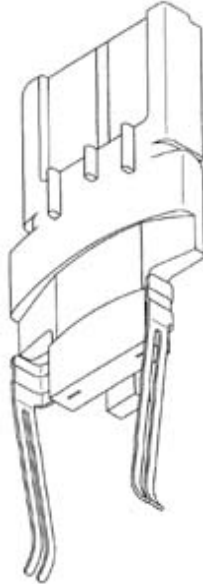

Design Number	217717	
Class	14-03	
1)LG Electronics Inc. 20, Yoido-Dong, Yongdungpo-Gu, Seoul, Korea 150721		
Date of Registration	12/08/2008	
Title	Mobile Phone	
Priority – 30-2008-0008547 28/02/2008 Korea(South)		
Design Number	217718	
Class	14-03	
1)LG Electronics Inc. 20, Yoido-Dong, Yongdungpo-Gu, Seoul, Korea 150721		
Date of Registration	12/08/2008	
Title	Cellular Phone	
Priority – 30-2008-0006790 18/02/2008 Korea(South)		
Design Number	217719	
Class	14-03	
1)LG Electronics Inc. 20, Yoido-Dong, Yongdungpo-Gu, Seoul, Korea 150721		
Date of Registration	12/08/2008	
Title	Cellular Phone	
Priority – 30-2008-0007806 22/02/2008 Korea(South)		

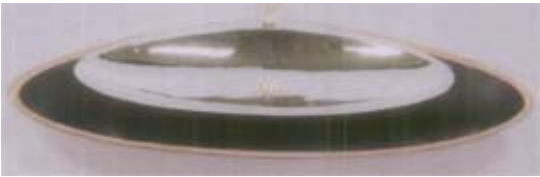
Design Number	217901	
Class	08-06	
1)Servotech Industries Near Bedipara Fire Station, Panjrapol, Bhavnagar Road, Rajkot-360003, Gujarat, India		
Date of Registration	18/08/2008	
Title	Hinge	
Priority – NA		
Design Number	217949	
Class	23-04	
1)ebm-papst Mulfingen GmbH & Co. KG Bachmuhle 2, 74673 Mulfingen, Germany		
Date of Registration	18/08/2008	
Title	Fan	
Priority – 000911441-0001 02/04/2008 OHIM		
Design Number	217950	
Class	23-04	
1)ebm-papst Mulfingen GmbH & Co. KG Bachmuhle 2, 74673 Mulfingen, Germany		
Date of Registration	18/08/2008	
Title	Fan	
Priority – 000911441-0001 02/04/2008 OHIM		

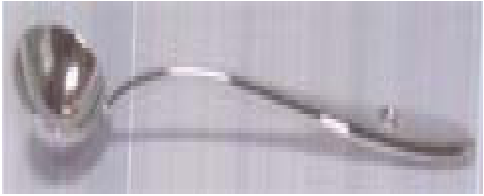
Design Number	217951	
Class	23-04	
1)ebm-papst Mulfingen GmbH & Co. KG Bachmühle 2, 74673 Mulfingen, Germany		
Date of Registration	18/08/2008	
Title	Fan	
Priority – 000911441-0001 02/04/2008 OHIM		
Design Number	218100	
Class	13-01	
1)Nidec Copal Corporation 2-18-10 Shimura, Itabashi-Ku, Tokyo 174-8550, Japan		
Date of Registration	25/08/2008	
Title	Weight for Vibration Motor	
Priority – 2008-020414 06/08/2008 Japan		
Design Number	218101	
Class	13-01	
1)Nidec Copal Corporation 2-18-10 Shimura, Itabashi-Ku, Tokyo 174-8550, Japan		
Date of Registration	25/08/2008	
Title	Terminal for Motor	
Priority – 2008-004701 29/02/2008 Japan		

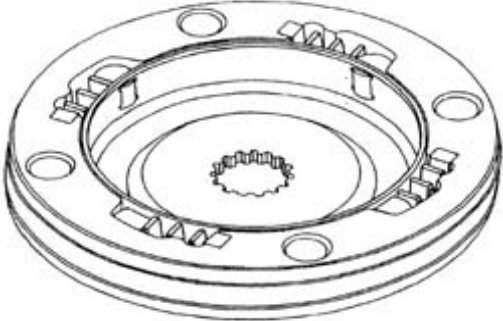
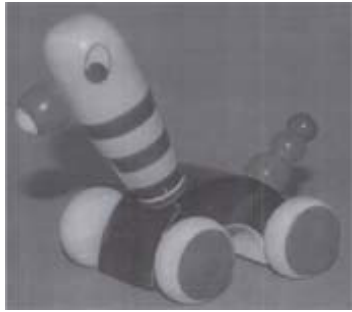
Design Number	218170	
Class	07-99	
1) Ravissant Pvt. Ltd. 50-51, Commercial Complex, New Friends Colony, New Delhi-110065		
Date of Registration	27/08/2008	
Title	Oyster Tray	
Priority – NA		
Design Number	218181	
Class	09-03	
1) Neil Gillan Beverly Pa;ace Bloc B, 13 Boulevard De Beigiques, MC 9800, Monaco		
Date of Registration	28/08/2008	
Title	Storage Box	
Priority – 000923016-0001 23/04/2008 OHIM		
Design Number	218205	
Class	07-03	
1) Ravissant Pvt. Ltd. 50-51, Commercial Complex, New Friends Colony, New Delhi-110065		
Date of Registration	28/08/2008	
Title	Spoon	
Priority – NA		

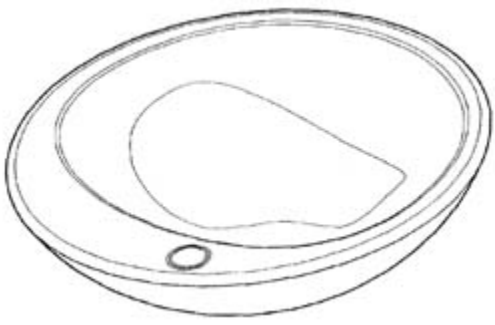
Design Number	218206	
Class	07-03	
1) Ravissant Pvt. Ltd. 50-51, Commercial Complex, New Friends Colony, New Delhi-110065		
Date of Registration	28/08/2008	
Title	Spoon	
Priority – NA		
Design Number	218226	
Class	12-16	
1) Nsk-Warner K. K. Nissei Bldg., 1-6-3 Ohsaki, Shinagawa-Ku, Tokyo, 141-8560, Japan		
Date of Registration	29/08/2008	
Title	One-Way Clutch	
Priority – 2008-015170 13/06/2008 Japan		
Design Number	218321	
Class	21-01	
1) Maya Organic India Private Limited No. 25/1-4, 9th Cross, JP Nagar 2nd Phase, Bangalore-560 078, Karnataka, India		
Date of Registration	01/09/2008	
Title	Toy	
Priority – NA		

Design Number	218419	
Class	28-03	
1)Koninklijke Philips Electronics N.V. Groenewoudseweg 1, 5621 BA Eindhoven, The Netherlands.		
Date of Registration	05/09/2008	
Title	Base Unit for Massager	
Priority – 00893367-0005 07/03/2008 OHIM		
Design Number	218448	
Class	02-02	
1)Charming Apparels (P) Ltd. 402-405, 1st Floor, Main Road, Chandni Chowk, Delhi-110006, India		
Date of Registration	08/09/2008	
Title	Dress Material	
Priority – NA		
Design Number	218523	
Class	09-03	
1)Mku Holdings Pvt. Ltd. 104, Munish Plaza, 20, Ansari Road, Darya Ganj, New Delhi-110002, India		
Date of Registration	11/09/2008	
Title	Cart for use by Vegetables and Fruits Hawkers	
Priority – NA		

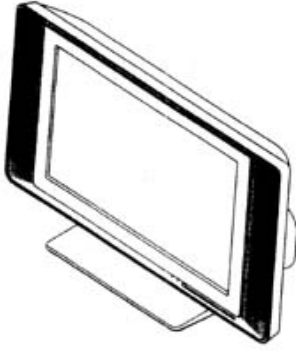
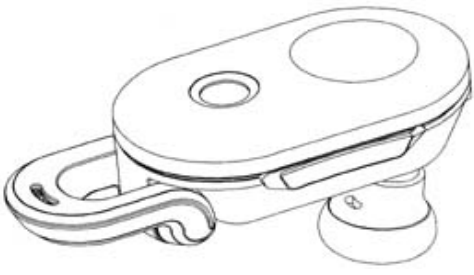
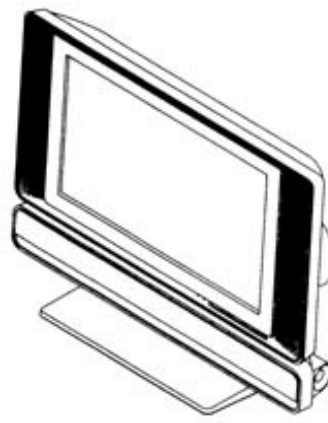

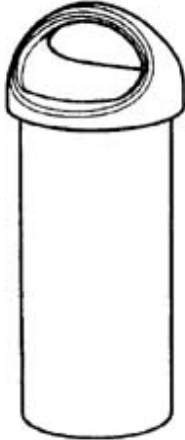
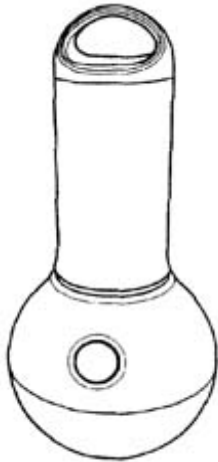
Design Number	218532	
Class	14-03	
1)Sony Corporation 1-7-1 Konan, Minato-Ku, Tokyo, Japan		
Date of Registration	11/09/2008	
Title	Television Receiver	
Priority – 200830141858.5 21/07/2008 China		
Design Number	218538	
Class	14-03	
1)Motorola, Inc. 1303 East Algonquin Road, Schaumburg, Illinois 60196, United States of America		
Date of Registration	11/09/2008	
Title	Headset for a Communication Device	
Priority – 29/305, 316 18/03/2008 U.S.A.		
Design Number	218549	
Class	14-03	
1)Sony Corporation 1-7-1 Konan, Minato-Ku, Tokyo, Japan		
Date of Registration	12/09/2008	
Title	Television Receiver	
Priority – 200830141856.6 21/07/2008 China		

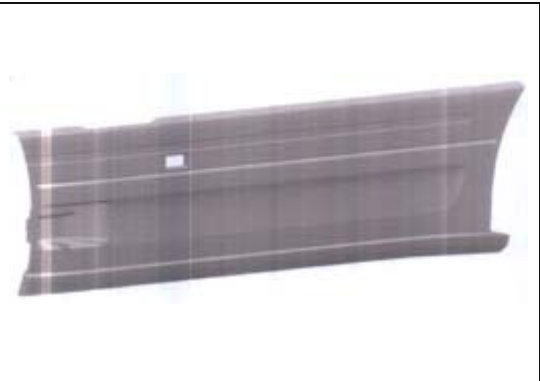
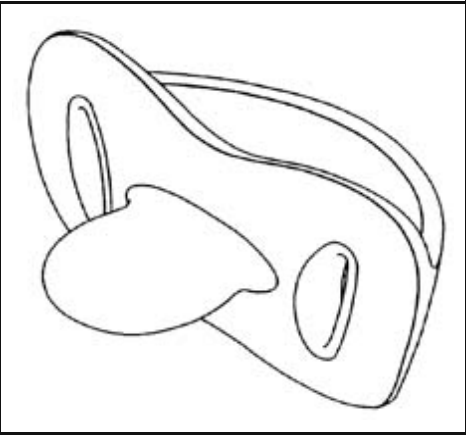
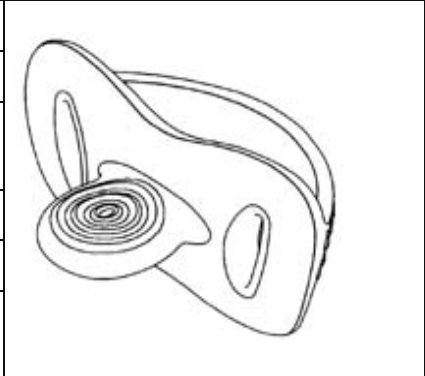
Design Number	218567	
Class	02-02	
1)Charming Apparels (P) Ltd. 402-405, 1st Floor, Main Road, Chandni Chowk, Delhi-110006, India.		
Date of Registration	15/09/2008	
Title	Dress Material	
Priority – NA		
Design Number	218665	
Class	13-02	
1)Koninklijke Philips Electronics N.V. Groenewoudseweg 1, 5621 BA Eindhoven, The Netherlands.		
Date of Registration	17/09/2008	
Title	Battery for Lamp	
Priority – NA		
Design Number	218666	
Class	26-02	
1)Koninklijke Philips Electronics N.V. Groenewoudseweg 1, 5621 BA Eindhoven, The Netherlands.		
Date of Registration	17/09/2008	
Title	Lamp	
Priority – NA		

Design Number	218798	
Class	12-16	
1)Scania CV AB 151 87 Sodertalje, Sweden		
Date of Registration	26/09/2008	
Title	Left Side Skirt	
Priority – 2008/0205 08/04/2008 Sweden		
Design Number	218821	
Class	24-04	
1)Playtex Products, Inc. 300 Nyala Farms Road, Westport, Connecticut 06880, USA		
Date of Registration	29/09/2008	
Title	Teething Device	
Priority – 29/307,034 28/03/2008 U.S.A.		
Design Number	218822	
Class	24-04	
1)Playtex Products, Inc. 300 Nyala Farms Road, Westport, Connecticut 06880, USA		
Date of Registration	29/09/2008	
Title	Teething Device	
Priority – 29/307,034 28/03/2008 U.S.A.		

Design Number	218866	
Class	09-01	
1)National Food Products Private Limited Unit No. L-1, L-2, L-3, Tax Center, Neat HDFC Bank Compound, Saki Vihar Road, Andheri (E), Mumbai-400072 Maharashtra, India.		
Date of Registration	30/09/2008	
Title	Bottle	
Priority – NA		
Design Number	218880	
Class	05-05	
1)Genesis Colors Pvt. Ltd. 1 A-2, Rao Tula Ram Marg, New Delhi-110022, India		
Date of Registration	30/09/2008	
Title	Saree	
Priority – NA		
Design Number	218904	
Class	05-05	
1)Genesis Colors Pvt. Ltd. 1 A-2, Rao Tula Ram Marg, New Delhi-110022, India		
Date of Registration	30/09/2008	
Title	Saree	
Priority – NA		

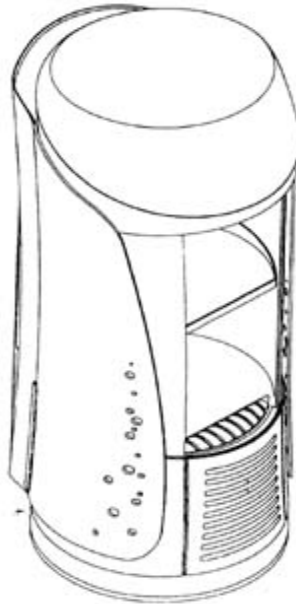
Design Number	218909	
Class	05-05	
1)Genesis Colors Pvt. Ltd. 1 A-2, Rao Tula Ram Marg, New Delhi-110022, India		
Date of Registration	30/09/2008	
Title	Saree	
Priority – NA		
Design Number	218915	
Class	05-05	
1)Genesis Colors Pvt. Ltd. 1 A-2, Rao Tula Ram Marg, New Delhi-110022, India		
Date of Registration	30/09/2008	
Title	Saree	
Priority – NA		
Design Number	218926	
Class	08-08	
1)Darshana Industries Pvt. Ltd. 63, Hadapsar, Pune-411 013, Maharashtra, India.		
Date of Registration	01/10/2008	
Title	Bracket	
Priority – NA		

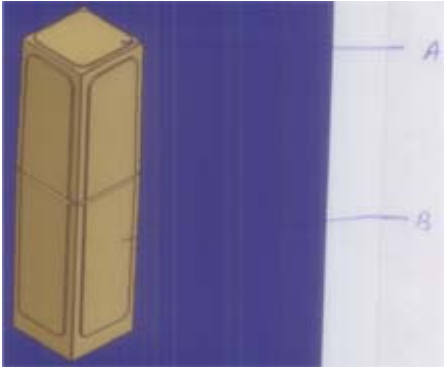
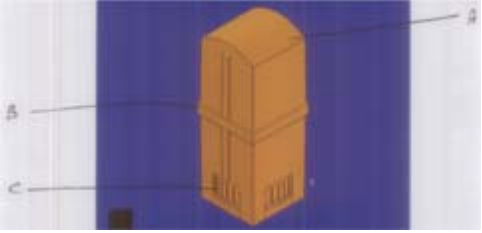
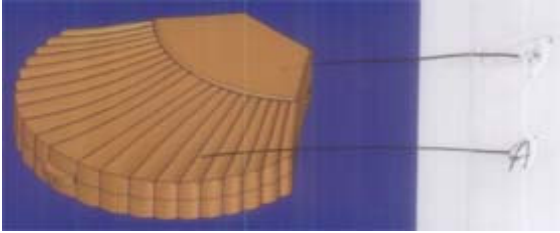

Design Number	218932	
Class	06-01	
1)Lalit Hiranandani D 23 Indrasukh Society, Four Bungalows, Andheri (West), Mumbai-400052, Maharashtra, India		
Date of Registration	01/10/2008	
Title	Chair	
Priority – NA		
Design Number	219167	
Class	07-01	
1)The Coca Cola Company One Coca Cola Plaza, N. W. Atlanta, Georgia 30313, United States of America		
Date of Registration	15/10/2008	
Title	Cooler	
Priority – 29/306,774 16/04/2008U.S.A.		
Design Number	219210	
Class	09-03	
1)Royal Dutch Cosmetics Pvt. Ltd. Baroda-Jambusar N. High way Road, At & Po. Dabhasa, Ta. Padra-391440, Dist. Baroda (Gujarat), India		
Date of Registration	16/10/2008	
Title	Container	
Priority – NA		

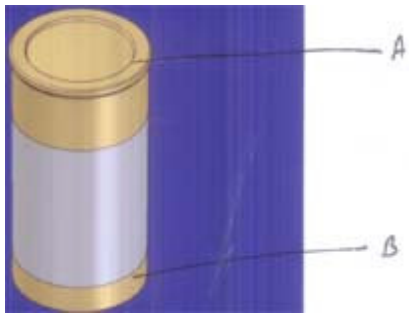
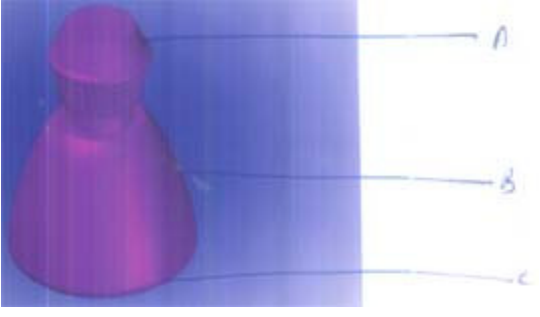
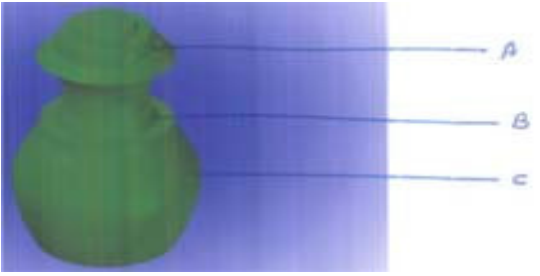

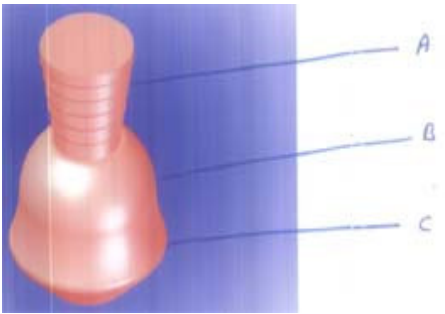
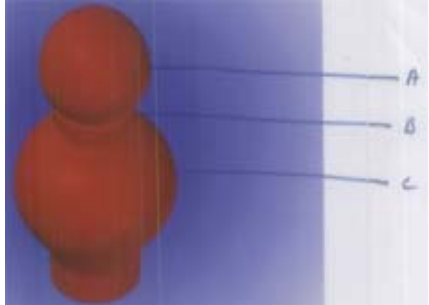
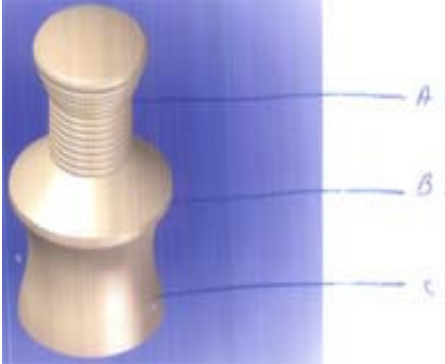
Design Number	219211	
Class	09-03	
1)Venezuela Beauty Exploration Pvt. Ltd Baroda-Jambusar N. High way Road, At & Po. Dabhasa, Ta. Padra-391440, Dist. Baroda (Gujarat), India		
Date of Registration	16/10/2008	
Title	Container	
Priority – NA		
Design Number	219212	
Class	09-03	
1)Venezuela Beauty Exploration Pvt. Ltd Baroda-Jambusar N. High way Road, At & Po. Dabhasa, Ta. Padra-391440, Dist. Baroda (Gujarat), India		
Date of Registration	16/10/2008	
Title	Container	
Priority – NA		
Design Number	219213	
Class	09-03	
1)Royal Dutch Cosmetics Pvt. Ltd. Baroda-Jambusar N. High way Road, At & Po. Dabhasa, Ta. Padra-391440, Dist. Baroda (Gujarat), India		
Date of Registration	16/10/2008	
Title	Container	
Priority – NA		

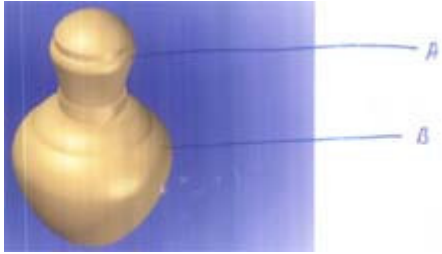
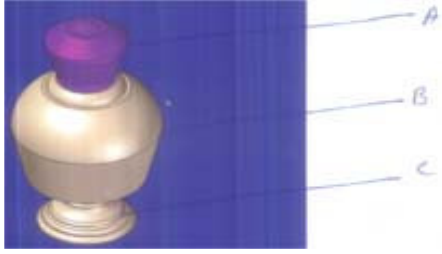
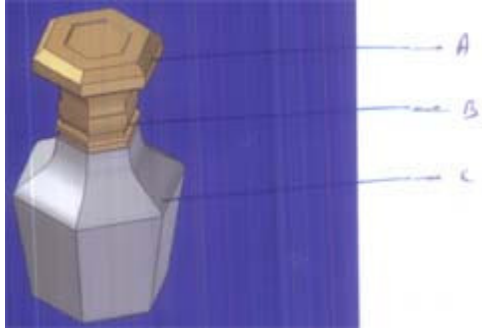
Design Number	219214	
Class	09-03	
1)Royal Dutch Cosmetics Pvt. Ltd. Baroda-Jambusar N. High way Road, At & Po. Dabhasa, Ta. Padra-391440, Dist. Baroda (Gujarat), India		
Date of Registration	16/10/2008	
Title	Container	
Priority – NA		
Design Number	219215	
Class	09-03	
1)Venezuela Beauty Exploration Pvt. ltd Baroda-Jambusar N. High way Road, At & Po. Dabhasa, Ta. Padra-391440, Dist. Baroda (Gujarat), India		
Date of Registration	16/10/2008	
Title	Container	
Priority – NA		
Design Number	219216	
Class	09-03	
1)Venezuela Beauty Exploration Pvt. Ltd Baroda-Jambusar N. High way Road, At & Po. Dabhasa, Ta. Padra-391440, Dist. Baroda (Gujarat), India		
Date of Registration	16/10/2008	
Title	Container	
Priority – NA		

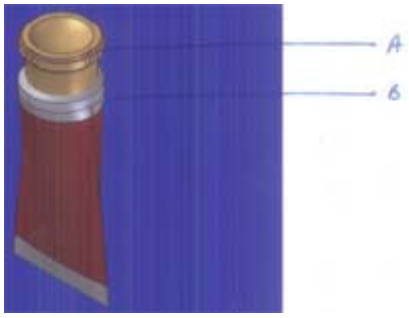
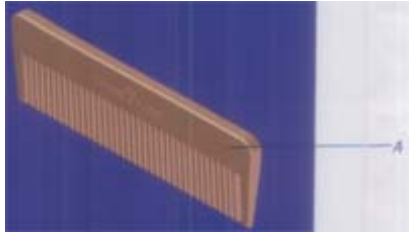

Design Number	219217	
Class	09-03	
1) Venezuela Beauty Exploration Pvt. Ltd Baroda-Jambusar N. High way Road, At & Po. Dabhasa, Ta. Padra-391440, Dist. Baroda (Gujarat), India		
Date of Registration	16/10/2008	
Title	Container	
Priority – NA		
Design Number	219218	
Class	09-03	
1) Venezuela Beauty Exploration Pvt. Ltd Baroda-Jambusar N. High way Road, At & Po. Dabhasa, Ta. Padra-391440, Dist. Baroda (Gujarat), India		
Date of Registration	16/10/2008	
Title	Container	
Priority – NA		
Design Number	219219	
Class	09-03	
1) Venezuela Beauty Exploration Pvt. Ltd Baroda-Jambusar N. High way Road, At & Po. Dabhasa, Ta. Padra-391440, Dist. Baroda (Gujarat), India		
Date of Registration	16/10/2008	
Title	Container	
Priority – NA		

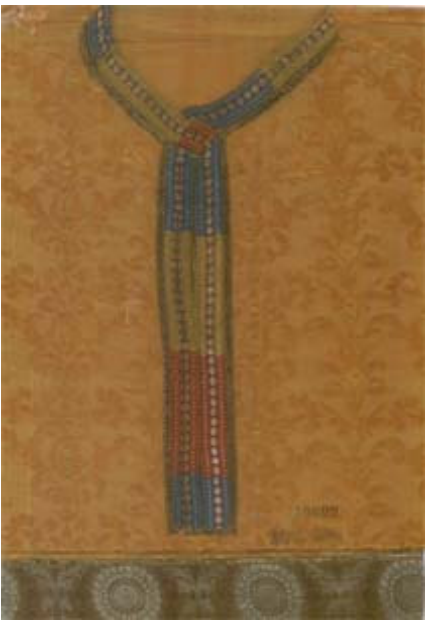
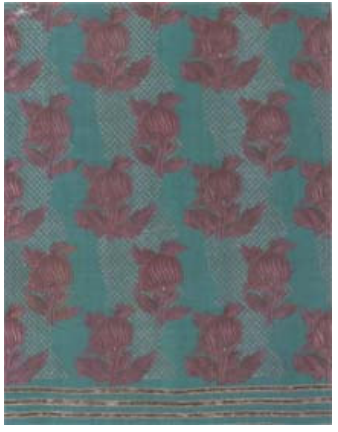

Design Number	219220	
Class	09-03	
1) Venezuela Beauty Exploration Pvt. Ltd Baroda-Jambusar N. High way Road, At & Po. Dabhasa, Ta. Padra-391440, Dist. Baroda (Gujarat), India		
Date of Registration	16/10/2008	
Title	Container	
Priority – NA		
Design Number	219221	
Class	09-03	
1) Venezuela Beauty Exploration Pvt. ltd 2) Venezuela Beauty Exploration Pvt. ltd		
Date of Registration	16/10/2008	
Title	Container	
Priority – NA		
Design Number	219222	
Class	09-03	
1) Venezuela Beauty Exploration Pvt. Ltd Baroda-Jambusar N. High way Road, At & Po. Dabhasa, Ta. Padra-391440, Dist. Baroda (Gujarat), India		
Date of Registration	16/10/2008	
Title	Container	
Priority – NA		

Design Number	219236	
Class	09-05	
1)Prachin Ayurvedic Sanskruti Pvt. Ltd. Baroda-Jambusar N. High way Road, At & Po. Dabhasa, Ta. Padra-391440, Dist. Baroda (Gujarat), India		
Date of Registration	16/10/2008	
Title	Tube	
Priority – NA		
Design Number	219297	
Class	28-03	
1)Paris Luxurious Care Pvt. Ltd. Baroda-Jambusar N. High way Road, At & Po. Dabhasa, Ta. Padra-391440, Dist. Baroda (Gujarat), India		
Date of Registration	17/10/2008	
Title	Comb	
Priority – NA		
Design Number	219298	
Class	28-03	
1)Paris Luxurious Care Pvt. Ltd. Baroda-Jambusar N. High way Road, At & Po. Dabhasa, Ta. Padra-391440, Dist. Baroda (Gujarat), India		
Date of Registration	17/10/2008	
Title	Comb	
Priority – NA		

Design Number	219300	
Class	28-03	
1)Paris Luxurious Care Pvt. Ltd. Baroda-Jambusar N. High way Road, At & Po. Dabhasa, Ta. Padra-391440, Dist. Baroda (Gujarat), India		
Date of Registration	17/10/2008	
Title	Comb	
Priority – NA		
Design Number	219575	
Class	11-02	
1)Vibhor Sogani A-47/10, G. F. D. L. F. Phase-I, Gurgaon-122001, Haryana, India		
Date of Registration	07/11/2008	
Title	Decoration Article	
Priority – NA		
Design Number	219576	
Class	26-05	
1)Vibhor Sogani A-47/10, G. F. D. L. F. Phase-I, Gurgaon-122001, Haryana, India		
Date of Registration	07/11/2008	
Title	Lamp Shade	
Priority – NA		

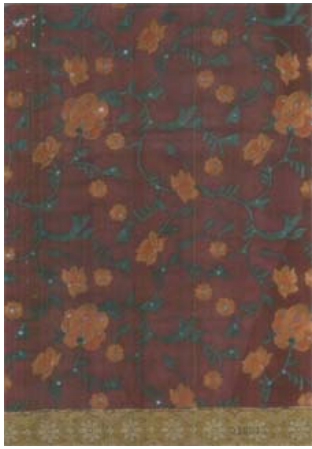
Design Number	219577	
Class	11-02	
1)Vibhor Sogani A-47/10, G. F. D. L. F. Phase-I, Gurgaon-122001, Haryana, India		
Date of Registration	07/11/2008	
Title	Decoration Article	
Priority – NA		
Design Number	219609	
Class	02-02	
1)Charming Apparels (P) Ltd. 402-405, 1st Floor, Main Road, Chandni Chowk, Delhi-110006, India		
Date of Registration	10/11/2008	
Title	Dress Material	
Priority – NA		
Design Number	219610	
Class	05-05	
1)Charming Apparels (P) Ltd. 402-405, 1st Floor, Main Road, Chandni Chowk, Delhi-110006, India		
Date of Registration	10/11/2008	
Title	Dress Material	
Priority – NA		

Design Number	219611	
Class	05-05	
1)Charming Apparels (P) Ltd. 402-405, 1st Floor, Main Road, Chandni Chowk, Delhi-110006, India		
Date of Registration	10/11/2008	
Title	Dress Material	
Priority – NA		
Design Number	219612	
Class	02-02	
1)Charming Apparels (P) Ltd. 402-405, 1st Floor, Main Road, Chandni Chowk, Delhi-110006, India		
Date of Registration	10/11/2008	
Title	Dress Material	
Priority – NA		
Design Number	219613	
Class	05-05	
1)Charming Apparels (P) Ltd. 402-405, 1st Floor, Main Road, Chandni Chowk, Delhi-110006, India		
Date of Registration	10/11/2008	
Title	Textile Fabric	
Priority – NA		

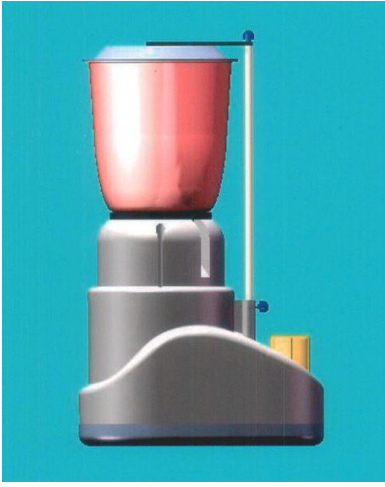
Design Number	219759	
Class	08-07	
1)Deckel Maho Pfronten GmbH Deckel Maho Strasse 1, 87459 Pfronten, Germany		
Date of Registration	19/11/2008	
Title	Key	
Priority – 40 2008 002 443.5 19/05/2008Germany		
Design Number	222232	
Class	23-04	
1)Crompton Greaves Limited 6th Floor, CG House, Dr. Annie Besant Road, Worli, Mumbai-400030, Maharashtra, India		
Date of Registration	01/04/2009	
Title	Ceiling Fan	
Priority – NA		
Design Number	222235	
Class	31-01	
1)Crompton Greaves Limited 6th Floor, CG House, Dr. Annie Besant Road, Worli, Mumbai-400030, Maharashtra, India		
Date of Registration	01/04/2009	
Title	Mixer Grinder	
Priority – NA		

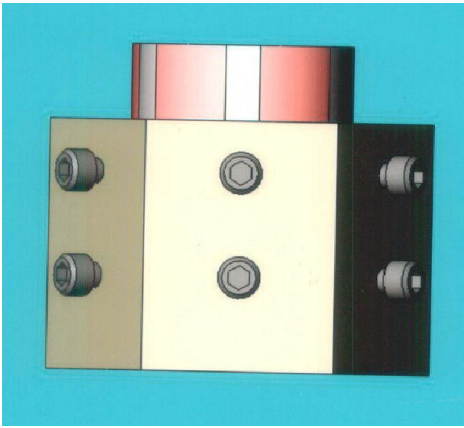
Design Number	222236	
Class	08-99	
1)Crompton Greaves Limited 6th Floor, CG House, Dr. Annie Besant Road, Worli, Mumbai-400030, Maharashtra, India		
Date of Registration	01/04/2009	
Title	Fixture	
Priority – NA		

Design Number	222238	
Class	23-04	
1)Crompton Greaves Limited 6th Floor, CG House, Dr. Annie Besant Road, Worli, Mumbai-400030, Maharashtra, India		
Date of Registration	01/04/2009	
Title	Ceiling Fan	
Priority – NA		

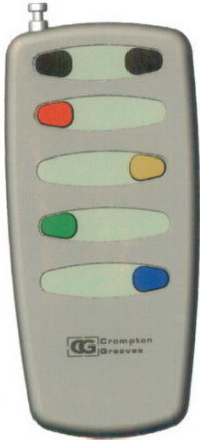
Design Number	222258	
Class	14-03	
1)Crompton Greaves Limited 6th Floor, CG House, Dr. Annie Besant Road, Worli, Mumbai-400030, Maharashtra, India		
Date of Registration	02/04/2009	
Title	Remote Control	
Priority – NA		

Design Number	222277	
Class	01-00	
1)M/S. Ever Bright Corporation C-39, Road No. 4, Sardar Estate, Ajwa Road, Vadodra, Gujrat, India		
Date of Registration	03/04/2009	
Title	25ml Bottle	
Priority – NA		

Design Number	223929	
Class	02-04	
1)Liberty Shoes Limited Liberty Puram, 13, Milestone, GT Karnal Road, Kutail, DT-Karnal-132001, Haryana, India		
Date of Registration	22/07/2009	
Title	Sole For Footwear	
Priority – NA		

Design Number	224491	
Class	06-01	
1)Attitudes 42, Madrampura, Civil Line Jaipur (Rajasthan) India		
Date of Registration	31/08/2009	
Title	Chair	
Priority – NA		