



CONTINUED FROM PART 1



INTRODUCTION

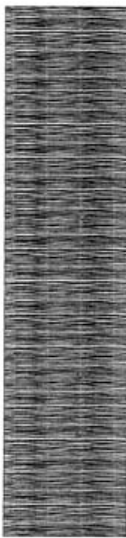

In view of the recent amendment made in the Designs (Amendment) Rules, 2008 with effect from 17/06/2008, Publication of the matter relating to Designs is being published in the Official Journal of The Patent Office. This Journal is being published on weekly basis on every Friday covering the various proceedings on Designs as required according to the provisions of under Rule 22, 25, 27 and 39 of the Design (Amendment) Rules, 2008. All the enquiries on this Official Journal and other information as required by the public should be addressed to the Controller General of Patents, Designs & Trade Marks. Suggestions and comments are requested from all quarters so that the content can be enriched.

REGISTRATION OF DESIGNS

The following designs have been registered. They are now open for public inspection. In the following each entry the Date of Registration is shown. The Priority Number, Priority Date and Priority Country are also shown.

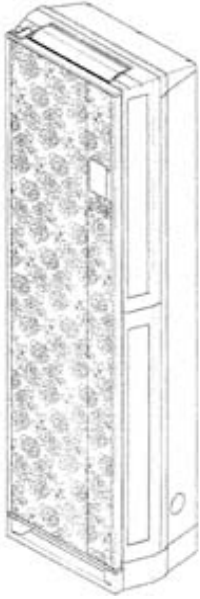

| | | |
|---|-----------------|---|
| Design Number | 210876 |  |
| Class | 02-04 | |
| 1)Premier Melamine Pvt. Ltd. B-1/6, Paschim Vihar, New Delhi-110 043, India | | |
| Date of Registration | 18/06/2007 | |
| Title | Shoe | |
| Priority: NA | | |
| Design Number | 211131 |  |
| Class | 05-06 | |
| 1)LG Electronics Inc. 20, Yoido-Dong, Yongdungpo-Gu, Seoul, Korea 150721 | | |
| Date of Registration | 09/07/2007 | |
| Title | Decorative Film | |
| Priority: 30-2007-0003426 25/01/2007 Korea(South) | | |
| Design Number | 211132 |  |
| Class | 05-06 | |
| 1)LG Electronics Inc. 20, Yoido-Dong, Yongdungpo-Gu, Seoul, Korea 150721 | | |
| Date of Registration | 09/07/2007 | |
| Title | Decorative Film | |
| Priority: 30-2007-0003427 25/01/2007 Korea(South) | | |

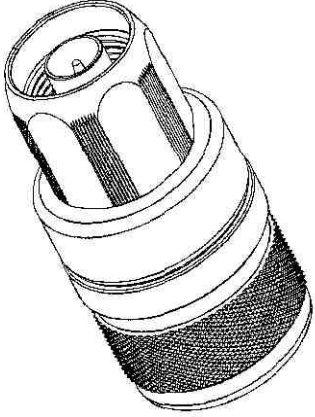
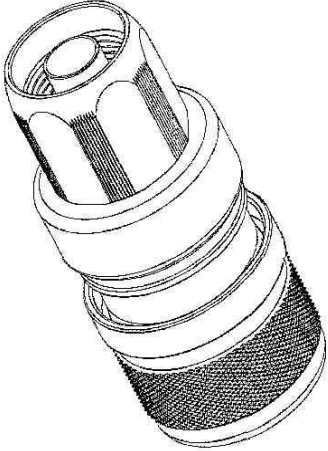

| | | |
|--|-------------------------------|---|
| Design Number | 211133 |  |
| Class | 23-04 | |
| 1)LG Electronics Inc. 20, Yoido-Dong, Yongdungpo-Gu, Seoul, Korea 150721 | | |
| Date of Registration | 09/07/2007 | |
| Title | Standing Type Air Conditioner | |
| Priority: 30-2007-0003488 25/01/2007 Korea(South) | | |
| Design Number | 211134 |  |
| Class | 23-04 | |
| 1)Lg Electronics Inc. 20, Yoido-Dong, Yongdungpo-Gu, Seoul, Korea 150721 | | |
| Date of Registration | 09/07/2007 | |
| Title | Standing Type Air Conditioner | |
| Priority: 30-2007-0003489 25/01/2007 Korea(South) | | |
| Design Number | 211135 |  |
| Class | 23-04 | |
| 1)Lg Electronics Inc. 20, Yoido-Dong, Yongdungpo-Gu, Seoul, Korea 150721 | | |
| Date of Registration | 09/07/2007 | |
| Title | Standing Type Air Conditioner | |
| Priority: 30-2007-0003490 25/01/2007 Korea(South) | | |

| | | |
|--|---|--|
| Design Number | 211136 |  |
| Class | 05-06 | |
| 1)Lg Electronics Inc. 20, Yoido-Dong, Yongsungpo-Gu, Seoul, Korea 150721 | | |
| Date of Registration | 09/07/2007 | |
| Title | Decorative Film | |
| Priority: 30-2007-0003424 25/01/2007 Korea(South) | | |
| Design Number | 212620 |  |
| Class | 24-03 | |
| 1)Dr. Kantilal Sancheti 16, Shivaji Nagar, Pune-411005, Maharashtra, India | | |
| Date of Registration | 24/09/2007 | |
| Title | Femoral Stem Prosthesis For Hip Replacement Surger | |
| Priority: NA | | |
| Design Number | 212621 |  |
| Class | 24-03 | |
| 1)Dr.Kantilal Hastilal Sancheti 16 Shivajinagar, Pune-411005, Maharashtra, India | | |
| Date of Registration | 24/09/2007 | |
| Title | femoral stem prosthesis for hip replacement surgery without cementing | |
| Priority: NA | | |

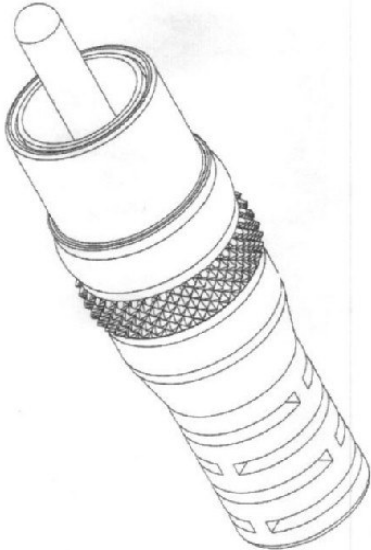
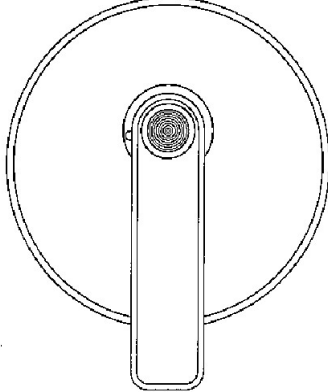
| | | |
|---|---|--|
| Design Number | 212622 |  |
| Class | 24-03 | |
| 1)Dr.Kantilal Hastilal Sancheti 16 Shivajinagar, Pune-411005, Maharashtra, India | | |
| Date of Registration | 24/09/2007 | |
| Title | femoral stem prosthesis for revision hip arthroplasty | |
| Priority: NA | | |
| Design Number | 212629 |  |
| Class | 02-04 | |
| 1)Liberty Shoes Limited, Liberty Puram, 13, Milestone, GT Karnal Raod, Kutail, DT-Karnal-132 001, Haryana, India. | | |
| Date of Registration | 24/09/2007 | |
| Title | Sole for Footwear | |
| Priority: NA | | |
| Design Number | 212633 |  |
| Class | 10-02 | |
| 1)Desco Von Schulthess AG Brandschenkestrasse 2, 8002 Zurich, Switzerland | | |
| Date of Registration | 26/03/2007 | |
| Title | Wristwatch | |
| Priority: 133726 26/03/2007 Switzerland | | |

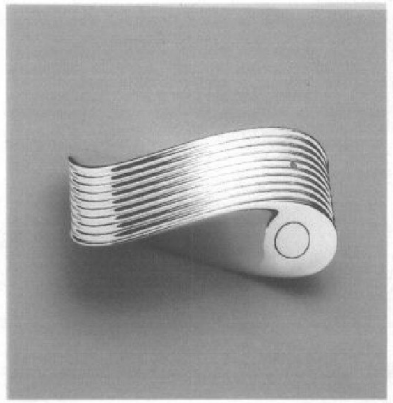

| | | |
|---|---|---|
| Design Number | 212634 |  |
| Class | 13-03 | |
| 1)John Mezzalingua Associates Inc 6176E Molloy Road, East Syracuse, NY 13067-0278, USA. | | |
| Date of Registration | 13/04/2007 | |
| Title | Closed Compression-Type Coaxial Cable Connector | |
| Priority: 29/278,908 13/04/2007 U.S.A. | | |
| Design Number | 212635 |  |
| Class | 13-03 | |
| 1)John Mezzalingua Associates Inc 6176E Molloy Road, East Syracuse, NY 13067-0278, USA. | | |
| Date of Registration | 25/09/2007 | |
| Title | Open Compression-Type Coaxial Cable Connector | |
| Priority: 29/278,907 13/04/2007 U.S.A. | | |
| Design Number | 212636 |  |
| Class | 13-03 | |
| 1)John Mezzalingua Associates Inc 6176E Molloy Road, East Syracuse, NY 13067-0278, USA. | | |
| Date of Registration | 13/04/2007 | |
| Title | Fiber Optic Cable Connector | |
| Priority: 29/278,905 13/04/2007 U.S.A. | | |

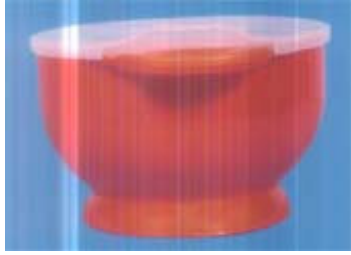
| | | |
|---|---------------------|---|
| Design Number | 212637 |  |
| Class | 13-03 | |
| 1)John Mezzalingua Associates Inc 6176E Molloy Road, East Syracuse, NY 13067-0278, USA. | | |
| Date of Registration | 25/09/2007 | |
| Title | RCA Cable Connector | |
| Priority: 29/278,903 13/04/2007 U.S.A. | | |
| Design Number | 212734 |  |
| Class | 14-01 | |
| 1)Nokia Corporation Keilalahdentie 4 Fin-02150 Espoo, Finland | | |
| Date of Registration | 02/04/2007 | |
| Title | Head for a Handset | |
| Priority: M20070062 02/04/2007 Finland | | |
| Design Number | 213090 |  |
| Class | 01-01 | |
| 1)Britannia Industries Limited 5/1A, Hungerford Street, Calcutta-700 017, West Bengal, India. | | |
| Date of Registration | 26/10/2007 | |
| Title | Biscuit | |
| Priority: NA | | |

| | | |
|---|------------------------------|---|
| Design Number | 213279 |  |
| Class | 09-01 | |
| 1)Kenzo 1 Rue Du Pont Neuf, 75001 Paris, France | | |
| Date of Registration | 02/11/2007 | |
| Title | Flask for Perfumery Products | |
| Priority: 07 2137 04/05/2007 France | | |
| Design Number | 213644 |  |
| Class | 07-01 | |
| 1)Bachpan Baby Care Sachin Kohli 1, Chikni-Ni-Chaal, Opp. Rajesh Shopping Centre, Goya-Gate Society, Pratapnagar, Vododara-390 004, Gujarat, India | | |
| Date of Registration | 05/12/2007 | |
| Title | Feeding Dish | |
| Priority: NA | | |
| Design Number | 213645 |  |
| Class | 08-01 | |
| 1)Bachpan Baby Care Sachin Kohli 1, Chikni-Ni-Chaal, Opp. Rajesh Shopping Centre, Goya-Gate Society, Pratapnagar, Vododara-390 004, Gujarat, India | | |
| Date of Registration | 05/12/2007 | |
| Title | Feeding Bowl | |
| Priority: NA | | |

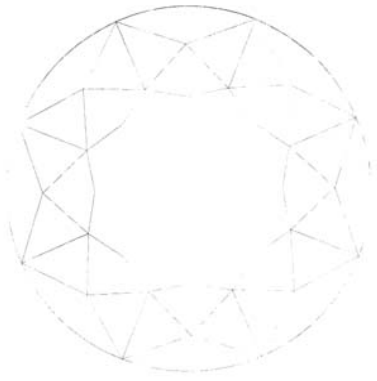
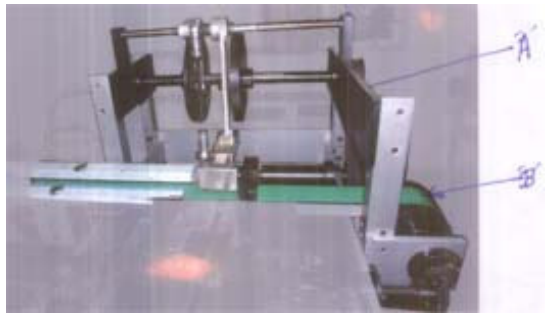
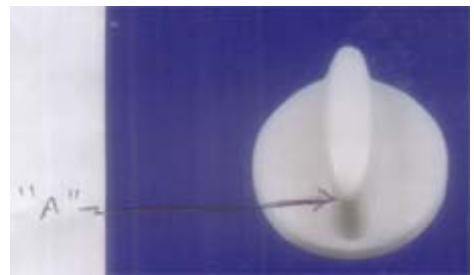
| | | |
|---|-------------------------------|---|
| Design Number | 213826 |  |
| Class | 07-02 | |
| 1)KANAK M. NIRMAL (HUF), BHARAT J. NIRMAL (HUF), KETAN M. NIRMAL AND MRS. ALPA R. NIRMAL., B-106, VIRWANI INDUSTRIAL ESTATE, GOREGAON (EAST), MAUBAI-400 063, MAHARAHSTRA, INDIA. 2)M/s Home Line Products | | |
| Date of Registration | 19/12/2007 | |
| Title | Containers | |
| Priority: NA | | |
| Design Number | 213897 |  |
| Class | 26-06 | |
| 1)Hyundai Motor Company 231 Yangjae-Dong, Seocho-dong, Kangnam-gu, Seoul, Republic of Korea. 2)Hyundai Mobis Co. Ltd. | | |
| Date of Registration | 26/12/2007 | |
| Title | Front Fog Lamp for Automobile | |
| Priority: 30-2007-0042492 12/10/2007 Korea(South) | | |
| Design Number | 214068 |  |
| Class | 09-01 | |
| 1)Rishabh Plast Corporation 5 Babulal Compound, Opp. N. M. Metal Industries, Cross Walbhat Road, Goregaon (E), Mumbai-63, Maharashtra, India. | | |
| Date of Registration | 03/01/2008 | |
| Title | Water Bottle | |
| Priority: NA | | |

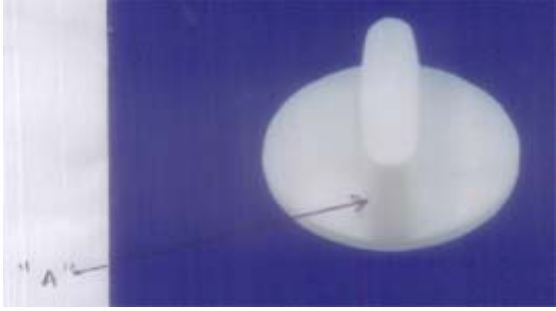
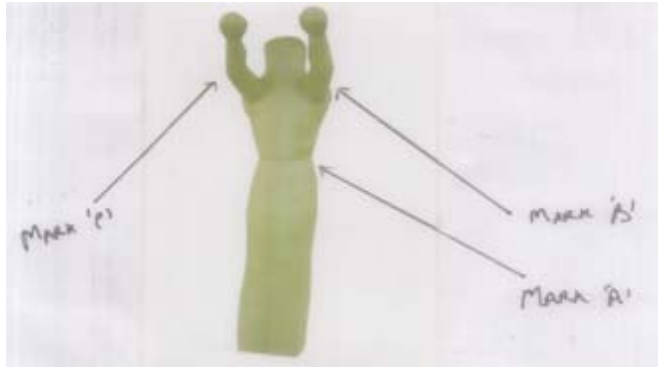
| | | |
|---|-----------------------|--|
| Design Number | 214693 |  |
| Class | 11-01 | |
| 1)GOENKA EXPORTS LIMITED., 1305, PANCHRATNA, OPERA HOUSE, MUMBAI-400 004, MAHARASHTRA, INDIA. | | |
| Date of Registration | 13/02/2008 | |
| Title | DIAMOND | |
| Priority: NA | | |
| Design Number | 215102 |  |
| Class | 15-09 | |
| 1)KHOSLA MACHINES (PVT.) LTD., B-17, INDUSTRIAL AREA, PHASE-II, MOHALI, PUNJAB, INDIA. | | |
| Date of Registration | 04/03/2008 | |
| Title | Wrapping Machine | |
| Priority: NA | | |
| Design Number | 215256 |  |
| Class | 08-06 | |
| 1)IDRIS ADAM BADHRA., GALA NO. 3, RAMJI PATEL COMPOUND, BEHIND BOMBAY HARDWARE, R.S.MARG, PATHANWADI, MALAD (EAST), MUMBAI-400 097, MAHARASHTRA, INDIA. | | |
| Date of Registration | 13/03/2008 | |
| Title | Switch Knob for Mixer | |
| Priority: NA | | |

| | | |
|--|------------------------|--|
| Design Number | 215257 |  |
| Class | 08-06 | |
| 1)IDRIS ADAM BADHRA., GALA NO. 3, RAMJI PATEL COMPOUND, BEHIND BOMBAY HARDWARE, R.S.MARG, PATHANWADI, MALAD (EAST), MUMBAI-400 097, MAHARASHTRA, INDIA. | | |
| Date of Registration | 13/03/2008 | |
| Title | Switch Knob For Mixer | |
| Priority: | | |
| NA | | |
| Design Number | 215464 |  |
| Class | 21-01 | |
| 1)AN MAIZO WORLDWIDE., BASTI BAWA KHEL, KAPURTHALA ROAD, JALANDHAR, PUNJAB, INDIA. | | |
| Date of Registration | 25/03/2008 | |
| Title | Toy for Wrestling Game | |
| Priority: | | |
| NA | | |
| Design Number | 215696 |  |
| Class | 09-01 | |
| 1)BAKUL RAGHAVBHAI KANANI., 2, ASTRON SOCIETY, BLOCK NO. 95, AMIN MARG, RAJ, RAJKOT, GUJARAT, INDIA. 2)Bakul Raghavbhai Kanani | | |
| Date of Registration | 03/04/2008 | |
| Title | Candy Container | |
| Priority: | | |
| NA | | |

| | |
|--|--------------|
| Design Number | 215791 |
| Class | 13-01 |
| 1)Crompton Greaves Limited 6Th Floor, CG House, Dr Annie Besant Road, Worli, Mumbai-400 030, Maharashtra, India. | |
| Date of Registration | 08/04/2008 |
| Title | An Endshield |
| Priority: NA | |





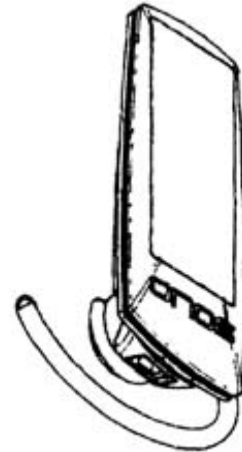

| | |
|---|-----------------------|
| Design Number | 215876 |
| Class | 14-01 |
| 1)Better Energy Systems, Ltd. 1508 6th Street, Berkely, California 94710, USA | |
| Date of Registration | 15/04/2008 |
| Title | Solar-Powered Headset |
| Priority: USSN 29/296,154 15/10/2007 U.S.A. | |

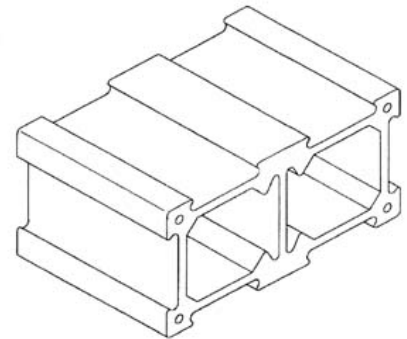

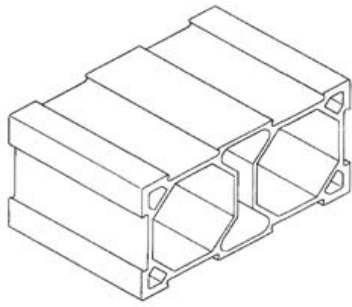
| | |
|--|-------------------|
| Design Number | 215993 |
| Class | 30-01 |
| 1)SUS CO., LTD., 105-1 OBANE, SHIMIZU-KU, SHIZUOKA-SHI, SHIZUOKA, 424-0103, JAPAN. | |
| Date of Registration | 23/04/2008 |
| Title | Building Material |
| Priority: 2007-029183 24/10/2007 Japan | |

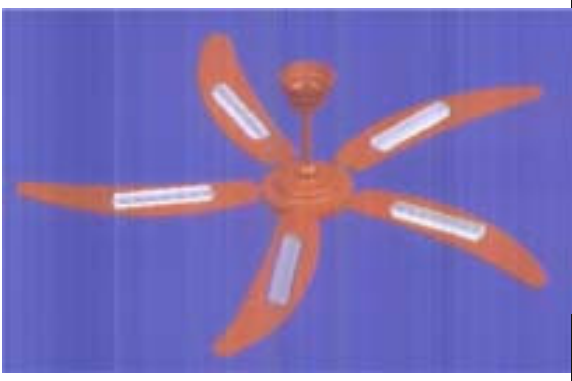

| | | |
|---|-----------------------|---|
| Design Number | 215994 |  |
| Class | 25-01 | |
| 1)SUS CO., LTD., 105-1 OBANE, SHIMIZU-KU, SHIZUOKA-SHI, SHIZUOKA, 424-0103, JAPAN. | | |
| Date of Registration | 23/04/2008 | |
| Title | Building Material | |
| Priority: 2007-029181 24/10/2007 Japan | | |
| Design Number | 216013 |  |
| Class | 24-99 | |
| 1)GABBAY, ELI., ELIACHAR, ELIAHU., Baniel, JACK., YOSSEPOWITCH, OFER., SADE HOCHSTADTER, DAN.,& OTHERS 19 HAHAVATZELET ST., RISHON LE-TZIYON 75507, ISRAEL. | | |
| 2)Gabbay, Eli | | |
| 3)Eliachar, Eliahu | | |
| 4)Baniel, jack | | |
| 5)Yossepowitch, Ofer | | |
| 6)Sade Hochstadter, Dan | | |
| 7)Bressler, Eyal | | |
| Date of Registration | 24/04/2008 | |
| Title | Rehabilitation Device | |
| Priority: 44935 25/10/2007 Israel | | |
| Design Number | 216066 |  |
| Class | 09-03 | |
| 1)Hindustan Unilever Limited Hindustan Lever House 165-166 Backbay Reclamation, Mumbai-400 020, Maharashtra, India. | | |
| Date of Registration | 28/04/2008 | |
| Title | Container | |
| Priority: 4005284 15/11/2007 U.K. | | |

| | | |
|--|-----------------------|---|
| Design Number | 216078 |  |
| Class | 12-05 | |
| 1)Standard Corporation (India) Limited Standard Chowk, Barnala-148101, Punjab, India | | |
| Date of Registration | 29/04/2008 | |
| Title | Backhoe Loader | |
| Priority: NA | | |
| Design Number | 216082 |  |
| Class | 15-03 | |
| 1)Gahir Industries Bus Stand, Sunam-148028, Punjab, India | | |
| Date of Registration | 29/04/2008 | |
| Title | Tractor Cum Harvester | |
| Priority: NA | | |
| Design Number | 216256 |  |
| Class | 23-04 | |
| 1)Crompton Greaves Limited 6th Floor, CG House, Dr Annie Besant Road, Worli, Mumbai-400 030, Maharashtra, India. | | |
| Date of Registration | 09/05/2008 | |
| Title | Ceiling Fan | |
| Priority: NA | | |



| | | |
|--|----------------|---|
| Design Number | 216258 |  |
| Class | 23-04 | |
| 1)Crompton Greaves Limited 6th Floor, CG House, Dr Annie Besant Road, Worli, Mumbai-400 030, Maharashtra, India. | | |
| Date of Registration | 09/05/2008 | |
| Title | Pedestal Fan | |
| Priority: NA | | |
| Design Number | 216542 |  |
| Class | 23-04 | |
| 1)ACME TELE POWER LIMITED., DLF INFINITY BUILDING TOWER C, 9TH FLOOR, DLF CYBER CITY, PHASE II, GURGAON-122 002, HARYANA, INDIA. | | |
| Date of Registration | 03/06/2008 | |
| Title | Battery Cooler | |
| Priority: NA | | |
| Design Number | 216543 |  |
| Class | 23-04 | |
| 1)ACME TELE POWER LIMITED., DLF INFINITY BUILDING TOWER C, 9TH FLOOR, DLF CYBER CITY, PHASE II, GURGAON-122 002, HARYANA, INDIA. | | |
| Date of Registration | 03/06/2008 | |
| Title | Battery Cooler | |
| Priority: NA | | |



| | | |
|---|------------|---|
| Design Number | 217165 |  |
| Class | 06-11 | |
| 1)Jaipur Rugs Co Pvt. Ltd. G-250, Mansarovar Industrial Area, Jaipur-302020, India. | | |
| Date of Registration | 16/07/2008 | |
| Title | Carpet | |
| Priority: NA | | |
| Design Number | 217166 |  |
| Class | 06-11 | |
| 1)Jaipur Rugs Co Pvt. Ltd. G-250, Mansarovar Industrial Area, Jaipur-302020, India. | | |
| Date of Registration | 16/07/2008 | |
| Title | carpet | |
| Priority: NA | | |
| Design Number | 217167 |  |
| Class | 06-11 | |
| 1)Jaipur Rugs Co Pvt. Ltd. G-250, Mansarovar Industrial Area, Jaipur-302020, India. | | |
| Date of Registration | 16/07/2008 | |
| Title | carpet | |
| Priority: NA | | |



| | | |
|---|------------|---|
| Design Number | 217169 |  |
| Class | 06-11 | |
| 1)Jaipur Rugs Co Pvt. Ltd. G-250, Mansarovar Industrial Area, Jaipur-302020, India. | | |
| Date of Registration | 16/07/2008 | |
| Title | carpet | |
| Priority: NA | | |
| Design Number | 217170 |  |
| Class | 06-11 | |
| 1)Jaipur Rugs Co Pvt. Ltd. G-250, Mansarovar Industrial Area, Jaipur-302020, India. | | |
| Date of Registration | 16/07/2008 | |
| Title | Carpet | |
| Priority: NA | | |
| Design Number | 217171 |  |
| Class | 06-11 | |
| 1)Jaipur Rugs Co Pvt. Ltd. G-250, Mansarovar Industrial Area, Jaipur-302020, India. | | |
| Date of Registration | 16/07/2008 | |
| Title | Carpet | |
| Priority: NA | | |

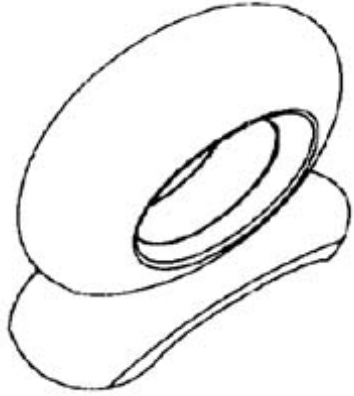

| | | |
|--|------------|---|
| Design Number | 217172 |  |
| Class | 06-11 | |
| 1)JAIPUR RUGS CO PVT. LTD., G-250, MANSAROVAR INDUSTRIAL AREA, JAIPUR-302020, INDIA. | | |
| Date of Registration | 16/07/2008 | |
| Title | CARPET | |
| Priority: NA | | |
| Design Number | 217174 |  |
| Class | 06-11 | |
| 1)Jaipur Rugs Co Pvt. Ltd. G-250, Mansarovar Industrial Area, Jaipur-302020, India. | | |
| Date of Registration | 16/07/2008 | |
| Title | Carpet | |
| Priority: NA | | |
| Design Number | 217175 |  |
| Class | 06-11 | |
| 1)Jaipur Rugs Co Pvt. Ltd., G-250, Mansarovar Industrial Area, Jaipur-302020, India. | | |
| Date of Registration | 16/07/2008 | |
| Title | Carpet | |
| Priority: NA | | |

| | | |
|---|------------|---|
| Design Number | 217176 |  |
| Class | 06-11 | |
| 1)Jaipur Rugs Co Pvt. Ltd. G-250, Mansarovar Industrial Area, Jaipur-302020, India. | | |
| Date of Registration | 16/07/2008 | |
| Title | Carpet | |
| Priority: NA | | |
| Design Number | 217177 |  |
| Class | 06-11 | |
| 1)Jaipur Rugs Co Pvt. Ltd. G-250, Mansarovar Industrial Area, Jaipur-302020, India. | | |
| Date of Registration | 16/07/2008 | |
| Title | Carpet | |
| Priority: NA | | |
| Design Number | 217178 |  |
| Class | 06-11 | |
| 1)Jaipur Rugs Co Pvt. Ltd. G-250, Mansarovar Industrial Area, Jaipur-302020, India. | | |
| Date of Registration | 16/07/2008 | |
| Title | Carpet | |
| Priority: NA | | |

| | | |
|---|------------|--|
| Design Number | 217179 |  |
| Class | 06-11 | |
| 1)Jaipur Rugs Co Pvt. Ltd. G-250, Mansarovar Industrial Area, Jaipur-302020, India. | | |
| Date of Registration | 16/07/2008 | |
| Title | Carpet | |
| Priority: NA | | |
| Design Number | 217180 |  |
| Class | 06-11 | |
| 1)Jaipur Rugs Co Pvt. Ltd. G-250, Mansarovar Industrial Area, Jaipur-302020, India. | | |
| Date of Registration | 16/07/2008 | |
| Title | Carpet | |
| Priority: NA | | |
| Design Number | 217182 |  |
| Class | 06-11 | |
| 1)Jaipur Rugs Co Pvt. Ltd. G-250, Mansarovar Industrial Area, Jaipur-302020, India. | | |
| Date of Registration | 16/07/2008 | |
| Title | Carpet | |
| Priority: NA | | |

| | | |
|---|------------------------|---|
| Design Number | 217201 |  |
| Class | 08-06 | |
| 1)Elephant Design Pvt. Ltd., 13 Kumar Srushti, Bavdhan, Pune-411 021, Maharashtra, India. | | |
| Date of Registration | 17/07/2008 | |
| Title | Knob | |
| Priority: NA | | |
| Design Number | 217424 |  |
| Class | 09-01 | |
| 1)Khoday India Limited Brewery House, 7th mile, Kanakapura Road, Bangalore-560 062, Karnataka State, India | | |
| Date of Registration | 30/07/2008 | |
| Title | Bottle without Cup | |
| Priority: NA | | |
| Design Number | 217495 |  |
| Class | 13-01 | |
| 1)Crompton Greaves Limited 6Th Floor, CG House, Dr Annie Besant Road, Worli, Mumbai-400 030, Maharashtra, India. | | |
| Date of Registration | 31/07/2008 | |
| Title | Rotating Machine Motor | |
| Priority: NA | | |

| | | |
|--|-------------------------|---|
| Design Number | 217642 |  |
| Class | 01-06 | |
| 1)Paragon Products B. V. Industrieweg 12 9641 HM Veendam the Netherlands | | |
| Date of Registration | 11/08/2008 | |
| Title | Dog Chews | |
| Priority: 000947361-0002 06/06/2008 OHIM | | |
| Design Number | 217766 |  |
| Class | 19-04 | |
| 1)S. Chand & Company Ltd. 7361, Ram Nagar, Qutab Road, New Delhi-110055, India | | |
| Date of Registration | 13/08/2008 | |
| Title | Cover of the Text Books | |
| Priority: NA | | |
| Design Number | 217767 |  |
| Class | 23-02 | |
| 1)Neoperl GMBH Klosterrunsstr. 11 79379 Mullheim Germany | | |
| Date of Registration | 13/08/2008 | |
| Title | Faucet Stream Former | |
| Priority: NA | | |

| | | |
|--|------------|---|
| Design Number | 217911 |  |
| Class | 07-01 | |
| 1)La Opala RG Limited 10th Floor, "Chitrakoot", 230A, A.J.C. Bose Road, Kolkata 700 020, West Bengal, India | | |
| Date of Registration | 18/08/2008 | |
| Title | Dish | |
| Priority: NA | | |
| Design Number | 217913 |  |
| Class | 07-01 | |
| 1)La Opala Rg Limited 10th Floor, "Chitrakoot", 230A, A.J.C. Bose Road, Kolkata 700 020, West Bengal, India | | |
| Date of Registration | 18/08/2008 | |
| Title | Dish | |
| Priority: NA | | |
| Design Number | 217914 |  |
| Class | 07-01 | |
| 1)La Opala Rg Limited 10th Floor, "Chitrakoot", 230A, A.J.C. Bose Road, Kolkata 700 020, West Bengal, India | | |
| Date of Registration | 18/08/2008 | |
| Title | Dish | |
| Priority: NA | | |

| | |
|--|------------|
| Design Number | 217923 |
| Class | 07-01 |
| 1)La Opala RG Limited 10th Floor, "Chitrakoot", 230A, A.J.C. Bose Road, Kolkata 700 020, West Bengal, India | |
| Date of Registration | 18/08/2008 |
| Title | Dish |
| Priority: NA | |





| | |
|--|------------|
| Design Number | 217924 |
| Class | 07-01 |
| 1)La Opala Rg Limited 10th Floor, "Chitrakoot", 230A, A.J.C. Bose Road, Kolkata 700 020, West Bengal, India | |
| Date of Registration | 18/08/2008 |
| Title | Dish |
| Priority: NA | |



| | |
|--|------------|
| Design Number | 217928 |
| Class | 07-01 |
| 1)La Opala Rg Limited 10th Floor, "Chitrakoot", 230A, A.J.C. Bose Road, Kolkata 700 020, West Bengal, India | |
| Date of Registration | 18/08/2008 |
| Title | Dish |
| Priority: NA | |

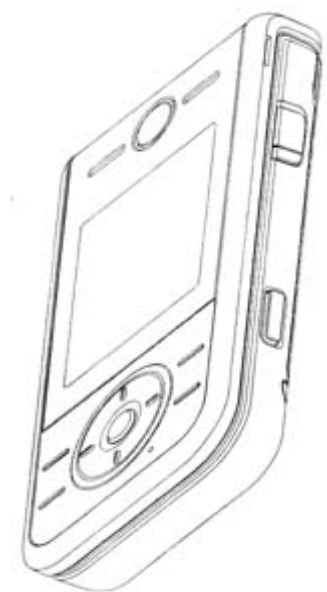

| | | |
|--|----------------------|---|
| Design Number | 217989 |  |
| Class | 14-03 | |
| 1) Motorola, Inc. 1303 East Algonquin Road, Schaumburg, Illinois 60196, United States of America | | |
| Date of Registration | 21/08/2008 | |
| Title | Communication Device | |
| Priority: NA | | |
| Design Number | 218111 |  |
| Class | 01-01 | |
| 1) ITC Limited Virginia House, 37 J. L. Nehru Road, Kolkata - 700 071, West Bengal, India | | |
| Date of Registration | 25/08/2008 | |
| Title | Chips | |
| Priority: NA | | |
| Design Number | 218390 |  |
| Class | 02-04 | |
| 1) Aztec Shoes Pvt. Ltd K-92, Udyog Nagar, Delhi-110041 (India) | | |
| Date of Registration | 05/09/2008 | |
| Title | Sole for Footwear | |
| Priority: NA | | |



| | | |
|---|--|--|
| Design Number | 218391 |  |
| Class | 02-04 | |
| 1)Aztec Shoes Pvt. Ltd K-92, Udyog Nagar, Delhi-110041 (India) | | |
| Date of Registration | 05/09/2008 | |
| Title | Sole for Footwear | |
| Priority: NA | | |
| Design Number | 218517 |  |
| Class | 10-04 | |
| 1)Shalabh Kumar rastogi H. No 93/18, First Floor, Friends Colony, Jharsa Road, Gurgaon-122001, Haryana, India | | |
| Date of Registration | 10/09/2008 | |
| Title | Composite Calibration/Verification Gauge | |
| Priority: NA | | |
| Design Number | 218535 |  |
| Class | 14-03 | |
| 1)Motorola, Inc. 1303 East Algonquin Road, Schaumburg, Illinois 60196, United States of America | | |
| Date of Registration | 11/09/2008 | |
| Title | Communication Device | |
| Priority: NA | | |



| | | |
|---|--|---|
| Design Number | 218571 |  |
| Class | 15-09 | |
| 1)Quill International Group Limited Castle Lane, Melbourne Derbyshire DE73 1DY United Kingdom | | |
| Date of Registration | 15/09/2008 | |
| Title | Sieving Hopper for Abrasive Blasting Apparatus | |
| Priority: NA | | |
| Design Number | 218679 |  |
| Class | 02-04 | |
| 1)Raj Laxmi Industries F-9, Udhyog nagar, Peeragarhi, New Delhi-110041, India | | |
| Date of Registration | 19/09/2008 | |
| Title | Shoe Sole | |
| Priority: NA | | |
| Design Number | 218680 |  |
| Class | 02-04 | |
| 1)Kavita Agarwal Raj Laxmi Industries, F-9, Udhyog Nagar, Peeragarhi, New Delhi-110041, India | | |
| Date of Registration | 19/09/2008 | |
| Title | Shoe Sole | |
| Priority: NA | | |

| | | |
|---|------------|---|
| Design Number | 218712 |  |
| Class | 09-01 | |
| 1)Parle Agro Private Limited Western Express Highway, Andheri (East), Mumbai-400 099, State of Maharashtra, India | | |
| Date of Registration | 24/09/2008 | |
| Title | Bottle | |
| Priority: NA | | |
| Design Number | 218788 |  |
| Class | 12-05 | |
| 1)M/s Escorts Construction Equipment Limited Plot No. 2, Sector-13, Faridabad-121 007 | | |
| Date of Registration | 26/09/2008 | |
| Title | Crane | |
| Priority: NA | | |
| Design Number | 218913 |  |
| Class | 05-05 | |
| 1)Genesis Colors Pvt. Ltd. 1 A-2, Rao Tula Ram Marg, New Delhi-110022, India | | |
| Date of Registration | 30/09/2008 | |
| Title | Saree | |
| Priority: NA | | |

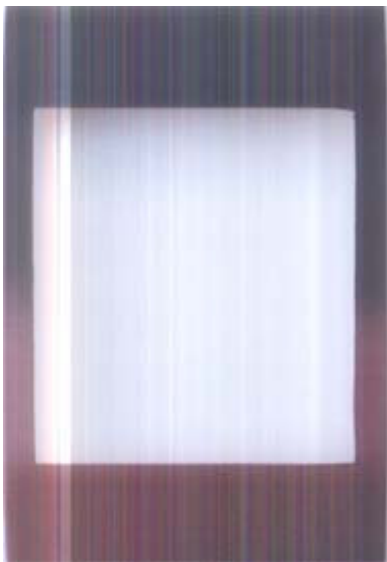

| | | |
|--|------------|--|
| Design Number | 218917 |  |
| Class | 05-05 | |
| 1)Genesis Colors Pvt. Ltd. 1 A-2, Rao Tula Ram Marg, New Delhi-110022, India | | |
| Date of Registration | 30/09/2008 | |
| Title | Saree | |
| Priority: NA | | |
| Design Number | 219062 |  |
| Class | 13-03 | |
| 1)Ajanta Limited Orpat Industrial Estate, Rajkot Highway, P.B. No. 115, morbi-363 641, State of Gujarat, India | | |
| Date of Registration | 13/10/2008 | |
| Title | Socket | |
| Priority: NA | | |
| Design Number | 219063 |  |
| Class | 13-03 | |
| 1)Ajanta Limited Orpat Industrial Estate, Rajkot Highway, P.B. No. 115, morbi-363 641, State of Gujarat, India | | |
| Date of Registration | 13/10/2008 | |
| Title | Socket | |
| Priority: NA | | |

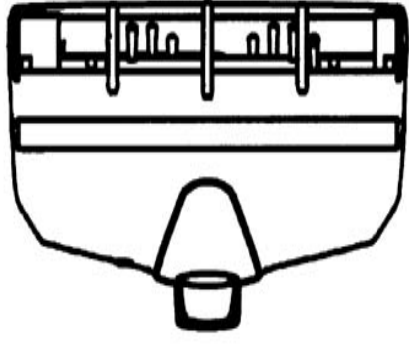
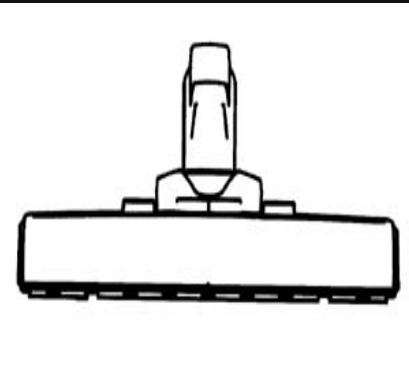
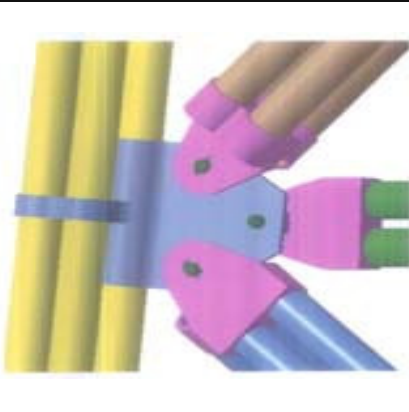

| | | |
|---|-----------------------------|---|
| Design Number | 219067 |  |
| Class | 13-03 | |
| 1)Ajanta Limited Orpat Industrial Estate, Rajkot Highway, P.B. No. 115, morbi-363 641, State of Gujarat, India | | |
| Date of Registration | 13/10/2008 | |
| Title | Switch with Indicator | |
| Priority: NA | | |
| Design Number | 219087 |  |
| Class | 13-03 | |
| 1)Ajanta Limited Orpat Industrial Estate, Rajkot Highway, P.B. No. 115, morbi-363 641, State of Gujarat, India | | |
| Date of Registration | 13/10/2008 | |
| Title | Cover for Socket | |
| Priority: NA | | |
| Design Number | 219088 |  |
| Class | 13-03 | |
| 1)Ajanta Limited Orpat Industrial Estate, Rajkot Highway, P.B. No. 115, morbi-363 641, State of Gujarat, India | | |
| Date of Registration | 13/10/2008 | |
| Title | Cover for Socket and Switch | |
| Priority: NA | | |

| | | |
|---|------------------|--|
| Design Number | 219089 |  |
| Class | 13-03 | |
| 1)Ajanta Limited Orpat Industrial Estate, Rajkot Highway, P.B. No. 115, morbi-363 641, State of Gujarat, India | | |
| Date of Registration | 13/10/2008 | |
| Title | Cover for Socket | |
| Priority: NA | | |
| Design Number | 219090 |  |
| Class | 13-03 | |
| 1)Ajanta Limited Orpat Industrial Estate, Rajkot Highway, P.B. No. 115, morbi-363 641, State of Gujarat, India | | |
| Date of Registration | 13/10/2008 | |
| Title | Cover for Switch | |
| Priority: NA | | |
| Design Number | 219091 |  |
| Class | 13-03 | |
| 1)Ajanta Limited Orpat Industrial Estate, Rajkot Highway, P.B. No. 115, morbi-363 641, State of Gujarat, India | | |
| Date of Registration | 13/10/2008 | |
| Title | Cover for Socket | |
| Priority: NA | | |

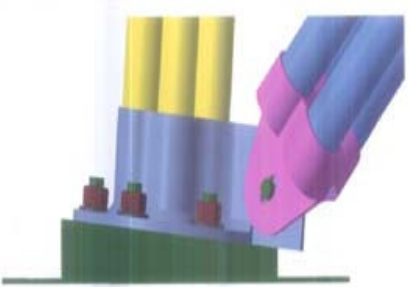
| | | |
|---|--------------------|--|
| Design Number | 219092 |  |
| Class | 13-03 | |
| 1)Ajanta Limited Orpat Industrial Estate, Rajkot Highway, P.B. No. 115, morbi-363 641, State of Gujarat, India | | |
| Date of Registration | 13/10/2008 | |
| Title | Holder | |
| Priority: NA | | |
| Design Number | 219093 |  |
| Class | 13-03 | |
| 1)Ajanta Limited Orpat Industrial Estate, Rajkot Highway, P.B. No. 115, morbi-363 641, State of Gujarat, India | | |
| Date of Registration | 13/10/2008 | |
| Title | Holder | |
| Priority: NA | | |
| Design Number | 219472 |  |
| Class | 21-02 | |
| 1)Sharma Exports B-16, Sports & Surgical Complex, Kapurthala Road, Jalandhar-144021 (Punjab) India. | | |
| Date of Registration | 29/10/2008 | |
| Title | Ball (Educational) | |
| Priority: NA | | |

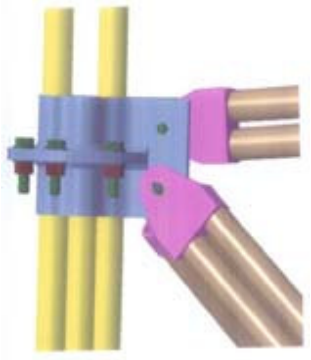
| | | |
|---|---------------------------|--|
| Design Number | 219479 |  |
| Class | 15-05 | |
| 1)Lux International AG Baarermatte, 6340 Baar, Switzerland | | |
| Date of Registration | 29/10/2008 | |
| Title | Vacuum Cleaner Nozzle | |
| Priority: DM/070 302 30/05/2008 Switzerland | | |
| Design Number | 219480 |  |
| Class | 15-05 | |
| 1)Lux International AG Baarermatte, 6340 Baar, Switzerland | | |
| Date of Registration | 29/10/2008 | |
| Title | Vacuum Cleaner Nozzle | |
| Priority: DM/070 302 30/05/2008 Switzerland | | |
| Design Number | 219625 |  |
| Class | 25-01 | |
| 1)Kalpesh Mahendrabhai Patel 202, Atlantic, IV, NR Natubhai Centre, Race Course, Vadodara - 390 007, Gujarat State, India | | |
| Date of Registration | 10/11/2008 | |
| Title | Joint for Composite Tower | |
| Priority: NA | | |

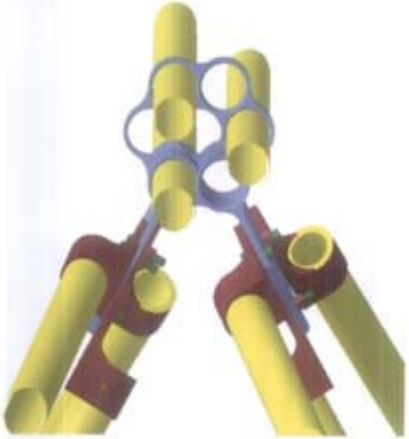
| | | |
|---|---------------------------|---|
| Design Number | 219626 |  |
| Class | 25-01 | |
| 1)Kalpesh Mahendrabhai Patel 202, Atlantic, IV, NR Natubhai Centre, Race Course, Vadodara - 390 007, Gujarat State, India | | |
| Date of Registration | 10/11/2008 | |
| Title | Joint for Composite Tower | |
| Priority: NA | | |
| Design Number | 219627 |  |
| Class | 25-03 | |
| 1)Kalpesh Mahendrabhai Patel 202, Atlantic, IV, NR Natubhai Centre, Race Course, Vadodara - 390 007, Gujarat State, India | | |
| Date of Registration | 10/11/2008 | |
| Title | Composite Tower | |
| Priority: NA | | |
| Design Number | 219628 |  |
| Class | 25-01 | |
| 1)Kalpesh Mahendrabhai Patel 202, Atlantic, IV, NR Natubhai Centre, Race Course, Vadodara - 390 007, Gujarat State, India | | |
| Date of Registration | 10/11/2008 | |
| Title | Joint for Composite Tower | |
| Priority: NA | | |

| | | |
|--|---------------------------|--|
| Design Number | 219629 |  |
| Class | 25-01 | |
| 1)Kalpesh Mahendrabhai Patel 202, Atlantic, IV, NR Natubhai Centre, Race Course, Vadodara - 390007, Gujarat State, India | | |
| Date of Registration | 10/11/2008 | |
| Title | Joint for Composite Tower | |
| Priority: NA | | |
| Design Number | 220040 |  |
| Class | 02-04 | |
| 1)Priyansh Plastic 15/2, Upside Industrial Area, Sikandra, Agra (U.P.) | | |
| Date of Registration | 05/12/2008 | |
| Title | Sole for Footwear | |
| Priority: NA | | |
| Design Number | 222267 |  |
| Class | 09-03 | |
| 1)Nipra Industries Private Limited 35-K, Laxmi Industrial Estate, New Link Road, Andheri (West), Mumbai-400053, Maharashtra, India | | |
| Date of Registration | 02/04/2009 | |
| Title | Mosquito Coil Tray | |
| Priority: NA | | |

| | | |
|---|------------|--|
| Design Number | 222421 |  |
| Class | 08-06 | |
| 1) Ramwshbhai Narsibhai Limbasiya Nagmati Metals, 2, Gokul Nagar, Opp. Shreeji Times, 500 feet Road, Kothariya Main Road, Rajkot-360003, Gujarat, India | | |
| Date of Registration | 16/04/2009 | |
| Title | Handle | |
| Priority: NA | | |